



**WIFI CONNECTION**

## iSense works with the dedicated Heating Management App MySense

Available on google play and App store, to optimise all your heating schedules and running costs by suggesting energy efficient modifications to specific room, dedicated programs tailored according to when the areas or specific zones are detected to be in occupation, and a secure keypad lock for rental housing, hotels, offices, shops or public building.

Download it from:

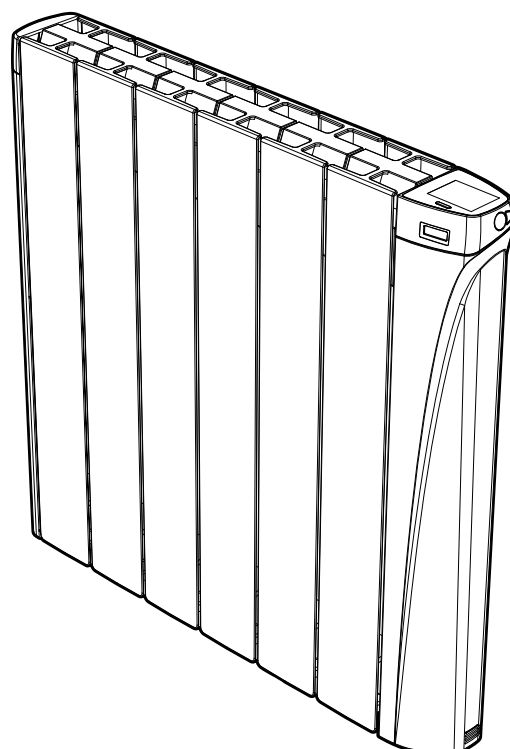

# INSTALLATION AND OPERATING iSense INSTRUCTIONS

**SMART THERMODYNAMIC FLUID ELECTRIC RADIATOR**  
GAUGE AND ENERGY CONSUMPTION INDICATION - OPEN WINDOW DETECTION - 7 DAY AND DAILY PROGRAMME - BOOST - PROGRAMMABLE HOLIDAY MODE - LIMIT OF THE TEMPERATURE SLOT  
PIN CODE LOCK

**ECO-DESIGN SMART FEATURES**  
OCCUPANCY DETECTION - AUTOMATIC PROGRAMMING WITH SELF-LEARNING  
PROCESS AND DUAL OPTIMISATION FEATURE



# TABLE OF CONTENTS

<b>Installing the heating device</b> .....	<b>4</b>
Warnings and precautions .....	4
Connecting, wall-mounting procedure.....	5
Wifi connection.....	7
<b>Overview</b> .....	<b>8</b>
Benefits.....	8
<b>Operating</b> .....	<b>9</b>
Overview .....	9
Power On/Heating standby mode .....	10
First power up .....	10
Selection of an operating mode .....	10
Manual and temporary exemption override to a current operating mode .....	11
Gauge consumption, energy savings.....	11
Adjustment of setting temperatures .....	12
Consumption indication accumulated in kWh, energy savings.....	12
Child anti-tamper, keypad lock/unlock .....	13
7 day and daily program integrated, energy savings .....	13
Automatic programming with self-learning process .....	13
7 day and daily program .....	13
Dual Optimisation feature .....	15
Open window detection, energy savings .....	15
Occupancy detection, energy savings .....	16
Information about remote control by pilot wire .....	16
Information about priorities between the different modes.....	17
Product information .....	17
<b>User settings</b> .....	<b>18</b>
Choice of language use.....	18
Wifi connection.....	18
Date setting .....	19
Time setting.....	19
Display .....	19
Regional units.....	19
Reset user settings .....	20
<b>Advanced settings</b> .....	<b>20</b>
Occupancy detection: activation/deactivation .....	20
Open window detection: Activation/deactivation of the automatic mode .....	21
User profile.....	21
Comfort setting temperature limitation.....	21
Boost duration .....	21
Aeration cycle time .....	21
Forget Wifi network.....	21
<b>Expert settings (reserved to the installer)</b> .....	<b>22</b>
Ambient temperature sensor.....	22
PIN code lock.....	22
Reset expert settings .....	23
<b>Power cut</b> .....	<b>23</b>
Other remotely management by power shutdown .....	23
In case a power cut, backup .....	23
<b>Troubleshooting</b> .....	<b>23</b>
Diagnosis support.....	23
<b>Technical informations</b> .....	<b>25</b>
Maintenance.....	25
Product label .....	25
Dimensional specifications .....	25
Technical information.....	25
Information requirements for electric local space heaters .....	26

# INSTALLING THE HEATING DEVICE

## WARNINGS AND PRECAUTIONS

### • Warnings

**All damage resulting from non-compliance with this advice gives rise to non-application of the terms of the manufacturer's warranty.**

- Do not use the appliance outdoors.
- Your appliance is intended for domestic usage and must not be used for other purposes.
- If the appliance has fallen on the ground, has been damaged or does not work properly, do not switch it on and ensure that the power supply to it has been cut off (by means of a fuse or a circuit breaker).
- Never disassemble the appliance. A badly-repaired appliance may present risks for the user.
- Please consult your local point of sales regarding any problems.
- If the power supply cable is damaged, it must be replaced by the manufacturer, its after-sales service department or another electrical professional in order to avoid any dangers arising.
- This heating device has been filled with a precise quantity of special fluid, (a product safety data sheet is available upon request). Should a leak occur, switch off the appliance, put it somewhere out of the way so that the fluid spill does not spread and so that the thermal fluid is not accidentally swallowed by a child, and then immediately contact the company that sold you the appliance or a representative of the manufacturer. Any operation requiring the opening of one of the plugs of the fluid tank should be carried out by the authorized representative of the manufacturer.
- When the heating appliance is scrapped, comply with legislation and regulations regarding disposal of the thermal fluid.



**-WARNING:** in order to avoid overheating, don't cover the device. If the device is covered, the rise in temperature will trigger the internal circuit breaker. Any damage caused by this will invalidate the warranty.

- This appliance can be used by children aged from 8 years and above and persons with reduced physical sensory or mental capabilities or lack of experience and knowledge, if they have been given supervision or instruction con-

cerning use of the appliance in a safe way and understand the hazards involved. Children shall not play with the appliance. Cleaning and user maintenance shall not be made by children without supervision.

Children of less than 3 years should be kept away unless continuously supervised.

Children aged from 3 years and less than 8 years shall only switch on/off the appliance provided that it has been placed or installed in its intended normal operating position and they have been given supervision or instruction concerning use of the appliance in a safe way and understand the hazards involved.

Children aged from 3 years and less than 8 years shall not plug in, regulate and clean the appliance or perform user maintenance.



**CAUTION - Some parts of this product can become very hot and cause burns. Particular attention has to be given where children and vulnerable people are present.**

When the appliance is heating, make sure they don't lean on it and don't play nearby. Vulnerable people and young children should not be left in the vicinity of the heater unless a suitable guard is fitted.

The normal cleaning is the responsibility of an adult who has read the instructions and understood the operation of the appliance.

**Any other operation or technical intervention must be performed by a qualified professional installer.**

- Do not insert objects or paper in the appliance.
- If the removal of the appliance is necessary, do not remove or refit the appliance onto the wall-mounting brackets without making sure it is cold and the main electrical supply and main board to the system are off.

## • Suggestion, positioning, location

Before connecting up the radiator to the mains power supply, switch off mains power at the main circuit breaker.

This electric radiator is a class II double insulated IP24 device, therefore it can be installed in all the rooms of a house including in safety zones 2 and Out of zone in bathrooms, but sheltered from water splashes.

The heating device must be installed in such a way that on-off switches and other control devices cannot be touched by a person located **in a bathtub or in a shower cabinet** (in accordance with I.E.E. Wiring Regulations (BS 7671:2008).

The radiator must not be located immediately below a socket-outlet.

The radiator must be installed at least 15cm from any obstacle (ie shelving, curtains, items of furniture, etc.).

A mean of disconnection from the mains electrical supply, the radiator should be provided with a local isolator switch capable of disconnecting all poles, having a contact separation of at least 3mm. In accordance with local Electrical Code regulations and installation rules. The radiator should only be used in conjunction with its existing fixed wiring.

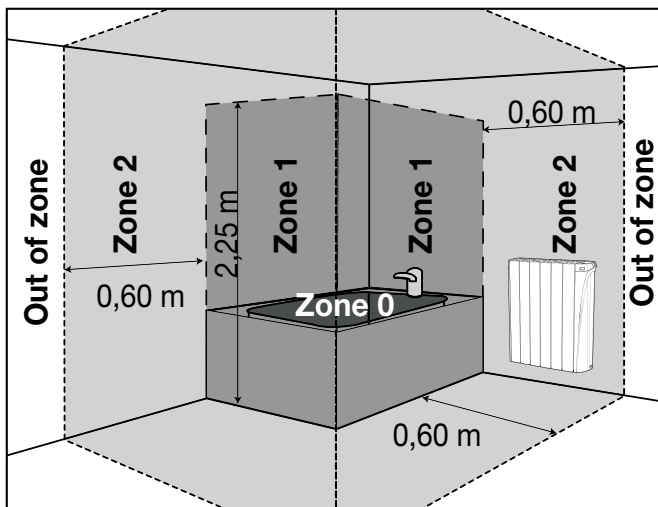

**Zone 0**

No electric heating device

**Zone 1**

**Zone 2**

Electric heating device of class II and IPX4 protected by a differential circuit breaker 30mA.

**Out of zone**

Electric heating device of class I or II protected by a differential circuit breaker 30mA.



**This picture is only for your reference. In any case, the product must be installed by a qualified professional installer, according to applicable standards and directives of the country in which it is installed.**

Locate the heater within minimum distances from obstacles.

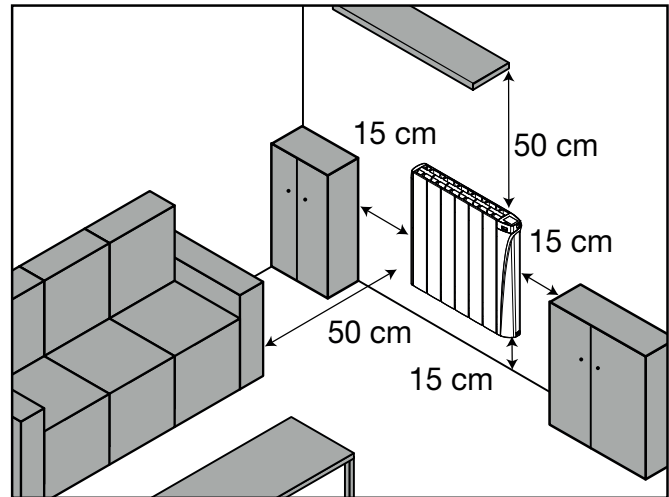

**Installation recommended** in the context of using automatic open window detection and occupancy detection.

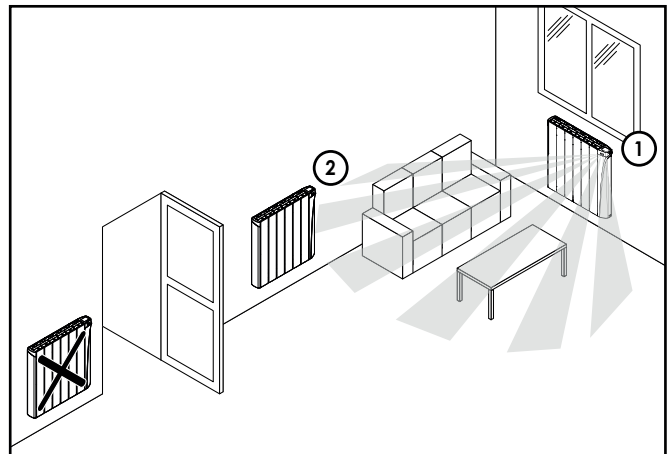

## Legend installation layout diagram

- ① = The ideal recommended location
- ② = Alternative location

## CONNECTING, WALL-MOUNTING PROCEDURE

### • Connecting the device

**All electrical installation work should be carried out by a qualified Electrician or other competent person.**

-The power supply of the device must have means of disconnection from main supply capable of disconnecting all poles, having a contact separation of at least 3mm in accordance with local regulations and installation rules, a protection by a 30mA RCD differential switch and a protection device against overloads adapted to the characteristics of the connecting line.

-Before you first use the equipment, check that the voltage used 230- 240V does indeed match that listed on the device.

-This radiator is a class II device (meaning that it has double electrical insulation). Connection to earth is prohibited.

-**The two wires (Live and Neutral) must be connected through a fused spur (FCU) or a standard electric plug which complies with applicable standards.**

## ELECTRICAL CONNECTIONS

Monophase power supply 230V +/-10% 50Hz

**⚠ You must isolate the pilot wire if it is not used. Do not connect the pilot wire (black) to hearth.**

- Blue-grey wire : Neutral
- Brown wire: Phase
- Black wire : Pilot wire (DO NOT CONNECT) ONLY TO BE USED WITH AN EXTERNAL CONTROLLER.

## • Positioning of the wall mounting bracket and tracing

Fix the bracket according to the dimensions specified in the enclosed table template, use the drilling template supplied to install and fix your radiator onto the wall.

References	Power outputs (W)	X = Width fixing holes in (mm)
ISEN-0750	750	218
ISEN-1000	1000	299
ISEN-1250	1250	461
ISEN-1500	1500	541
ISEN-2000	2000	784

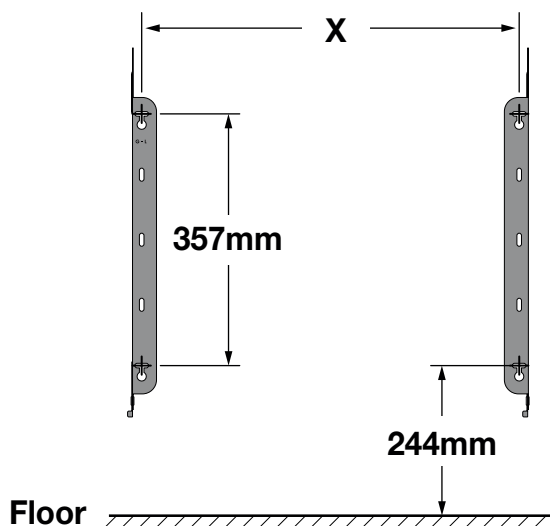

## Stage 1

Open the template and position it against the wall, at the desired location. Ensure that the bottom of the template touches the floor or the top of the skirting board, in order that the fitting height can be adjusted.

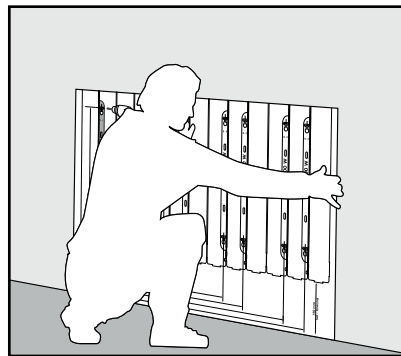

## • Installation of the wall-mounting brackets

### Stage 2

Find the power of your radiator and drill the corresponding holes into the wall.

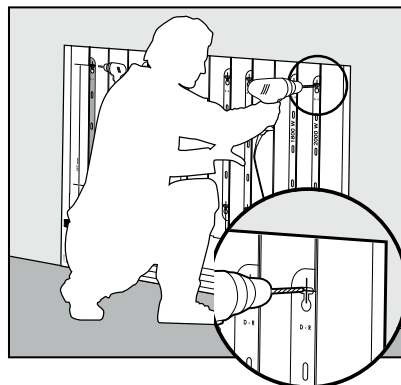

### Stage 3

Remove the template then screw the wall-mounting brackets of the electric radiator into the wall.

**IMPORTANT: use a screw anchor which is suitable in relation to the wall type (screws and screw anchors not supplied: screw Ø 6mm max).**

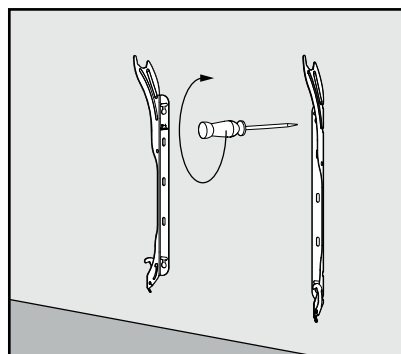

## • Installing of the radiator on the wall-mounting brackets

1- Take the radiator by the sides and lift it slightly by presenting it parallel to the wall.

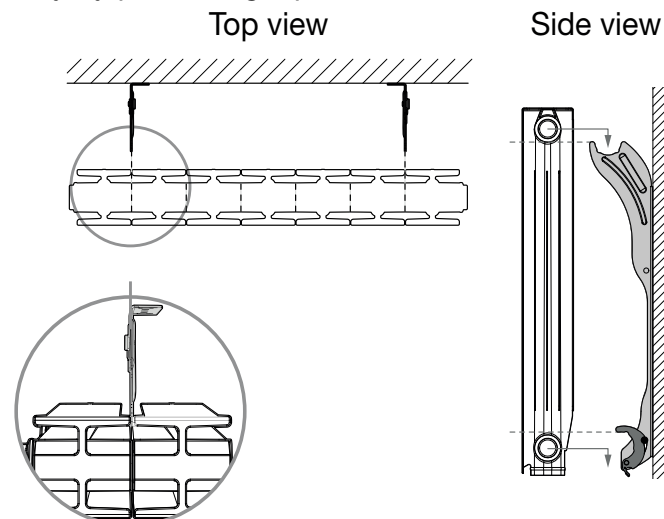

2- Place the radiator on the wall-mounting brackets.

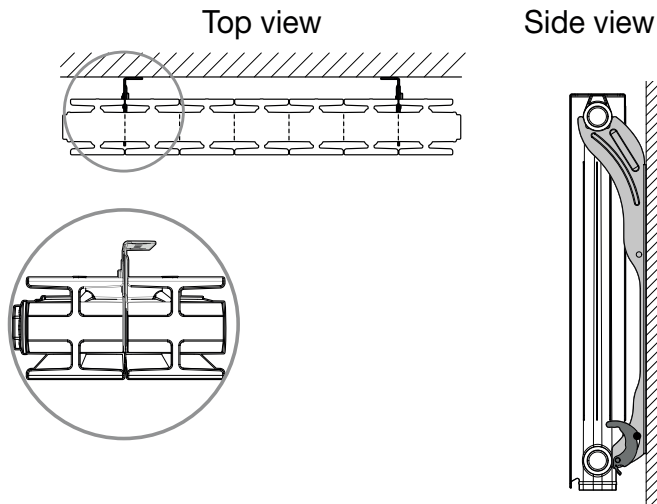

At the back of the product, make sure that each wall-mounting brackets are inserted between the intermediate fins without altering them.

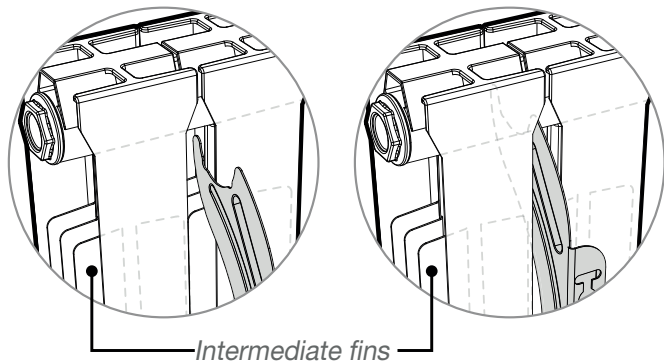

The wall mounting brackets are designed to secure the installation and to limit the translational movements of the device in case of impact.

### • Automatic lock of wall-mounting brackets

After the establishment of the radiator on the wall-mounting brackets, proceed to the installation locking in the following order:

1- Fold down the hooks.

2- The rivet goes down into the notch and automatically locks the wall-mounting bracket. Make sure that the rivet is well down at the end of the notch.

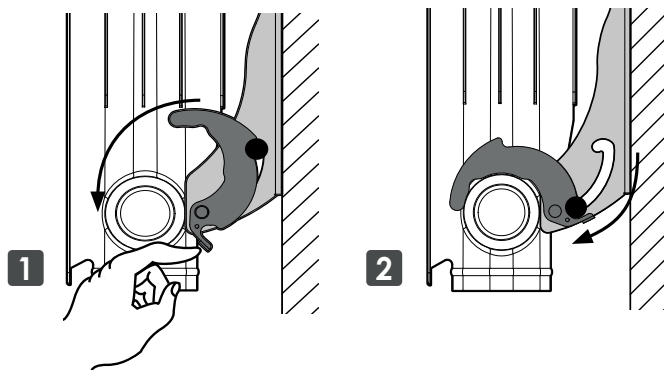

The anti-tilt safety is in place, the radiator can not be unhooked from the wall without unlocking.

## WIFI CONNECTION

Your radiator has been specially designed to be connected directly to your home router without the need of a hub.

To pair the device with your wireless network, proceed in the following order:

### • On the radiator

1- From the main screen, press and select Settings.

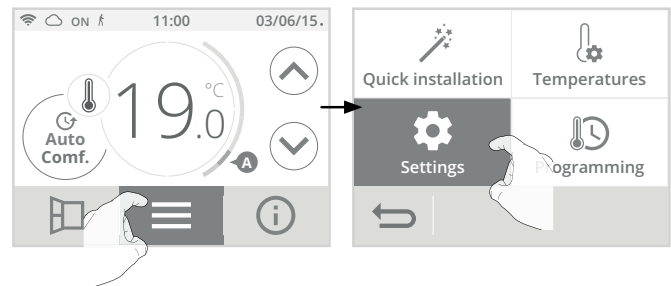

2- From Settings, press Network.

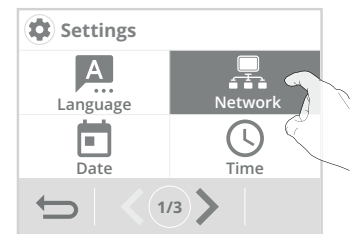

3- Press Connection to start the pairing process.

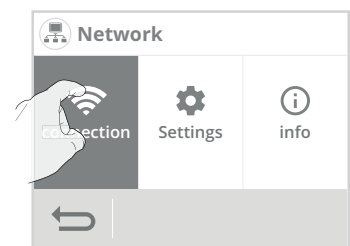

4- Press OK.

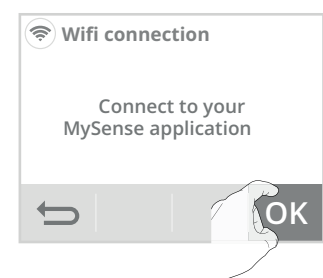

5- Your device is in connection mode. Please refer to the instructions on your application and follow the instructions until the complete connection of the device.

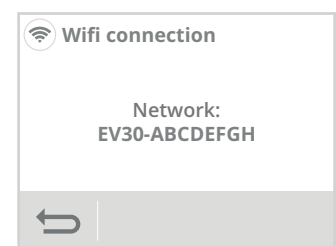

**Note:** The following 3 screens will appear when the connection is made. You have nothing to do on the product.

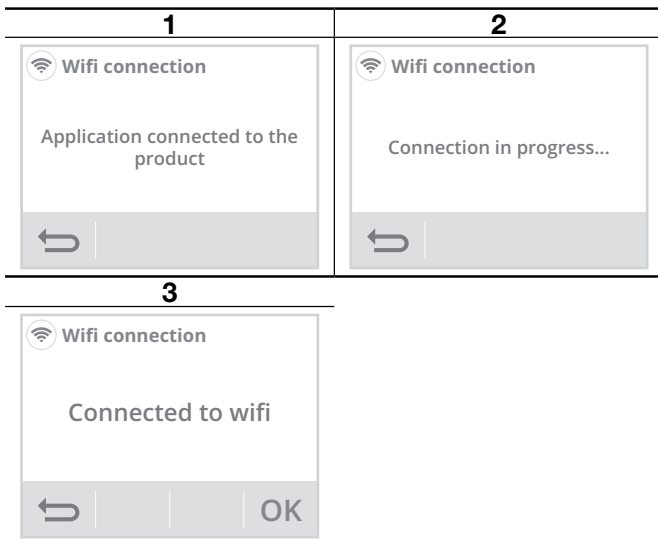

Once the product is connected, press **OK** to exit the connection mode. The unit automatically returns to the setup menu.

## OVERVIEW

Thank you for choosing one of our products we are confident that you will get many years of service.

Our stylish, innovative range of Thermodynamic fluid electric radiators was designed and developed to be maintenance free and bring you the comfort of heating with significant energy savings thanks to its smart features. Your IntelliHeat radiator incorporates innovative technologies designed for your comfort and to increase your energy saving, control performance PID (stability), occupancy detection, open window detection, 7 day and daily program, optimisation feature.

In new build or renovation applications, our radiators will provide you with comfort and satisfaction!

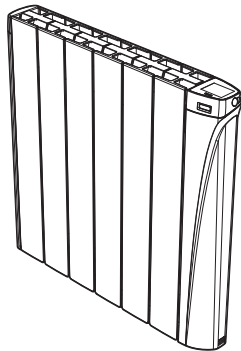

## BENEFITS

**Discover the true vocation of connected objects: manage, control your comfort and your energy budget**

- **Internet connection through your internet provider box**, without any other accessory.
- **Control and remote control from a smartphone, tablet or PC.**
- **Free web based App, app to download on Apple IOS and Android platforms: my-sense.co.uk**
- **Supervision and control of the installation in 3 levels:** all connected products of the housing, part of the housing (zone) or the level of the connected product.
- **Visualization of the operating status, settings and weather.**
- **Real-time information:** notifications, news feed, alerts.
- **Remote contingency management to save money when I'm away and anticipate heating up when I return.**
- **Control:** interact, schedule, adjust at any time.
- **Optimisation of consumption:** display of consumption in kWh or in £, display of the consumption history on day, week, month, year with possible comparison between 2 periods given, savings wizard and predictive system of consumption, anticipation and optimisation of consumption.

- **Ultra secure system:** Secure cloud design with backup security and localization of hosted data in EUROPE.
- **Seven different outputs (from 750W to 2000W)** to ensure the perfect heating solution for every room size, thus enabling you to optimize your electricity bills in line with your actual needs.
- **The comfort of central heating:** This concept with thermodynamic fluid circulation ensures a gentle heat and a stable temperature. The aluminum alloy heating body optimizes the heat diffusion.
- **Stylish design:** the perfect finish of the radiator with steel cheeks covered with epoxy paint makes it exclusive and sober style. It fits perfectly into any style of home.
- **Help for the visually impaired:** the button  power on/Heating standby mode is in relief to be easily identifiable to the touch. The device has audible beeps indicating the change from the heating standby mode to active mode.
- **Easy to set:** controls are positioned on the upper part of the radiator and have a backlight color touch screen for easy access and viewing. The interface is simple, straightforward and intuitive.
- **Gauge consumption:** An automatic indication of the level of energy consumption according to the setting temperature.
- **Energy consumption indication:** posting of the estimated amount of energy consumed in kWh since the last reset to 0 of the energy meter as well as for the current month and year.

## New smart features

- **Open window detection:** Automatic switching to frost protection mode when I-sense detects a significant drop in temperature.
- **Occupancy detection integrated:** During an unoccupied period, I-sense decreases automatically and progressively the temperature setting.
- **Smart Auto-programmable radiator:** The radiator I-sense adopts the learning mode as soon as it is put into operation and without any prior adjustment, this enables it to understand and memorize your life patterns: detecting and adapting to periods of absence and presence. The initial learning phase lasts 7 days, but the product will perpetually learn and adapt to changes in your occupancy patterns, adapting week after week to optimize to any changes. The products intelligent algorithm analyzes this information in real-time in order to optimize and adapt the program for the coming weeks. The goal: to make your life easier, to anticipate your comfort needs and to continuously maximum energy savings.
- **Dual optimisation feature, allows you to optimize your programming by favouring comfort or savings:** Dependent on various parameters: inertia of the room, ambient temperature, desired temperature, seasonality, the radiator will calculate and optimize its programming for the periods of comfort and economy (Eco) depending on your preference:
  - **Whilst in the OPTI ECO (priority to economy) mode**, the processors within the radiator will calculate the best compromise to guarantee maximum energy efficiency throughout the programmed periods of temperature variation (increase/decrease). This mode effectively accepts a slight reduction in the temperature levels both at the beginning and the end of the comfort periods, to maximize energy efficiency.
  - **Whilst in the OPTI COMFORT (priority to comfort) mode**, the processors within the radiator will calculate the best compromise to guarantee maximum user comfort throughout the programmed periods of temperature variation (increase/decrease). This mode will look to anticipate and maintain the set comfort temperature during all detected periods of occupancy within the area.
- **7 day program:** In addition to the auto-programming, you have the option, for each day of the week, of assigning one of the 7 available programs.
- **Special safety for social or private rental housing:**
  - Limits of the adjustment range of the Comfort setting temperature.
  - Administrator/installer PIN code.
- **4 User profiles to adapt to each need.**
- **Boost:** Raises the heat of the room for an adjustable time and in a punctual manner.
- **Programmable holiday mode:** Frost protection for a long-scheduled absence.
- **Automatic changeover summer / winter of the timer.**
- **"Smart" electronic controller:** This means stable and accurate



temperatures in your room all year round.

- **Setting temperature can be viewed in all operating modes.**
- **Active memory:** Permanent backup of all settings and programming.
- **Overheating protection:** The radiators are equipped with a system protecting the device against any overheating.

- **No risk of the radiator falling on the wall:** Secure patented wall brackets fixing system.
- **Child anti-tamper:** Keypad lock, making changes impossible.

# OPERATING

## OVERVIEW

### A- Indicators:

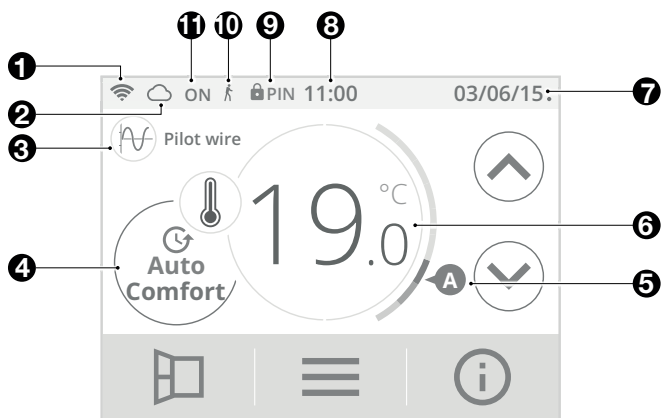

- 1 Wifi connection
- 2 Account login My sense
- 3 Manual override or pilot wire
- 4 Current operating mode
- 5 Gauge consumption
- 6 Setting temperature
- 7 Date
- 8 Hour
- 9 PIN code lock
- 10 Occupancy detection indicator
- 11 Heat demand

### B- Controls and navigation:

#### • Home screen

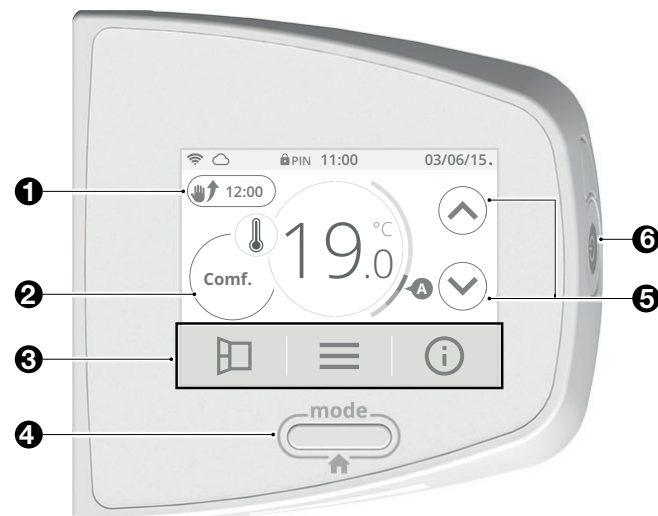

- 1 Cancellation of the current exemption
- 2 Operating modes access
- 3 Navigation bar from left to right:
  - Manual open window
  - Menu
  - Information
- 4 Operating modes display
- 5 Increase / Decrease the temperature
- 6 Power on/Heating standby mode

#### • Setting screens

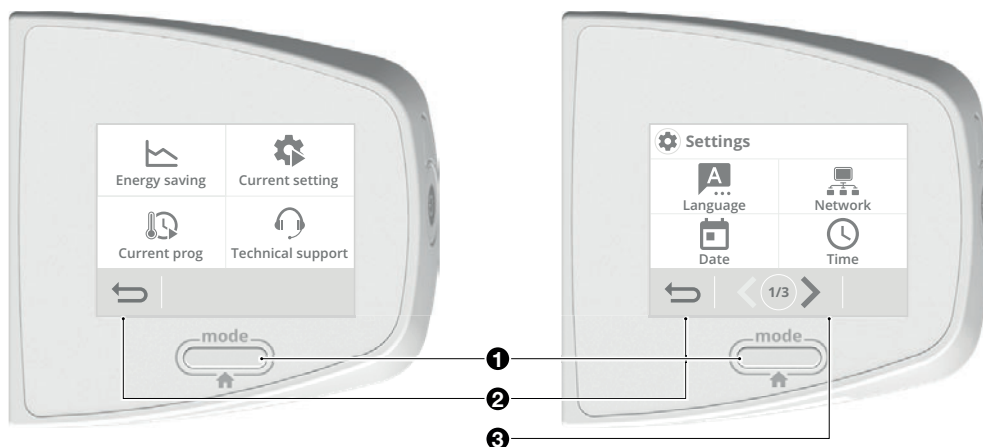

- 1 Back to main screen
- 2 Back to the settings menu
- 3 Navigation in the Settings menu with the indication of screens number

**Important: During navigation, pressing the or button does not save the settings made.**

## POWER ON/HEATING STANDBY MODE

### Power on feature

Press the  button located on the side of the device to put it in operation in Auto mode.



### Help for the visually impaired: sound signals

The device makes two short beeps to notify that it is in operation, in Auto mode.

### Heating standby mode

This function allows you to stop the heating in summer, for example. Press the  button to put the device in Heating standby mode.



### Help for the visually impaired: sound signals



The device makes one short beep to notify that it is in Heating standby mode.

## FIRST POWER UP

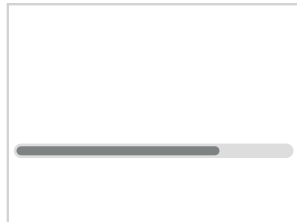
During the first power-up of your device, a progress bar appears to inform you that the software is loading.



Once the load has been loaded, a quick start procedure is automatically proposed in order to set the main settings necessary for the correct operation of the product.

Follow the steps below using the navigation arrows   and select the desired setting by pressing directly on the screen:

<p><b>Step 1</b></p>	<p><b>Step 2</b></p>
<p><b>Step 3</b></p>	<p><b>Step 4</b></p>
<p><b>Step 5</b></p>	<p><b>Step 6</b></p>

<p><b>Step 7</b></p>	<p><b>Step 8</b></p>
<p><b>Step 9</b></p>	<p><b>Step 10</b></p>
<p><b>Step 11</b></p>	

Press **OK** to confirm the settings. You can return to these settings at any time by pressing , then selecting **Quick Installation**. The main screen appears. By default, the device is in Auto Comfort mode (according to the programming selected in step 8 of the start-up).

## SELECTION OF AN OPERATING MODE

From the main screen, you can access the operating modes by pressing **Auto Comfort** displayed on the screen or

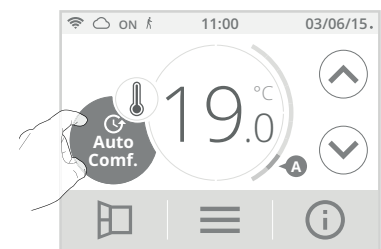
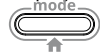

OR



View the different modes available with the navigation arrows and select the desired mode by pressing directly on the screen.

## Mode description

## Display

### • Auto Mode

In Auto mode, the device will execute the mode orders in line with the selected program.

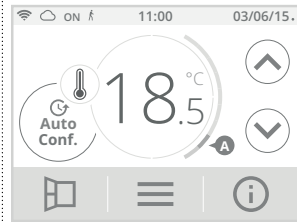

## 2 different cases depending on your set-up

### 1 7 day and daily program

Your radiator has been programmed and is executing Comfort and Eco mode orders in line with the settings and time periods you have selected (see "7 day and daily program integrated" chapter page 13).

### 2 Programming by pilot wire

If you do not want to use the programming feature. Orders sent by the pilot wire will only be applied **in Auto mode**, thus your radiator will automatically receive and apply the programmed orders sent by your power manager or your time switches (see Information about remote control by pilot wire chapter page 16).

### • Comfort temperature

Non-stop Comfort mode. The radiator will operate 24 hours a day to achieve the temperature which has been set (e.g. 19°C). The Comfort mode temperature level can be set by the user (see Adjustment of setting temperatures chapter page 12).

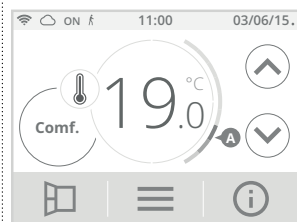

### • Eco temperature

Eco, which means the Comfort Mode temperature minus 3.5°C. This enables you to lower the temperature without having to reset the Comfort Mode temperature. Select this mode for short-term absences (between 2 and 24h) and during the night.

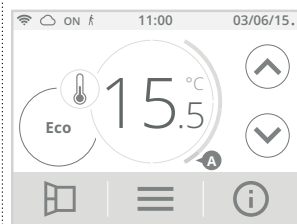

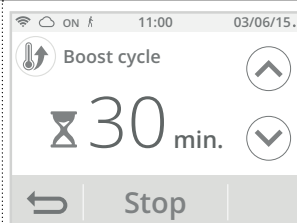

### • Boost Mode

In Boost mode, the setting temperature is up to the Comfort temperature + 2°C (for example if the Comfort temperature is set to 19°C, the boost will temporarily increase it to 21°C).



The Boost is active for an adjustable time of 60 min (see page 21 for changing the boost duration).

During the first minute, you can modify the Boost duration from 30 to 180 minutes by intervals of 10 min by pressing  or . This change will be saved and executed for the next Boost.

After one minute, the countdown begins.

**Note:** beyond a minute, you can temporarily change the duration for this period only. It will be applied for this activated Boost and non-recurring for the next Boosts.

### Stop the Boost

**Manual stop:** At anytime, you can stop the Boost and return to the previous mode by pressing **Stop**.

**Automatic stop:** If the room temperature reaches the Comfort temperature + 2°C (in our example 21°C) during the countdown, then the Boost stops. The device does not heat anymore but the Boost is still on, the countdown, the symbol  and the heating indicator **ON** are on the display. When the temperature drops 2°C below the comfort temperature (in our example 20°C); the Boost will be reactivated until the end of the countdown.

## Mode description

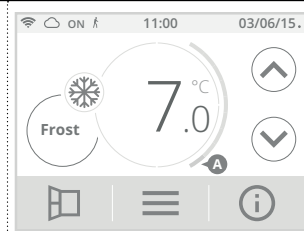

## Display

•  **Frost protection mode**  
Frost protection mode, enables you to protect your installation against the effects of cold weather, by maintaining a minimum temperature of 7°C. Select this mode when you will be away from your home for a long time (more than 5 days).

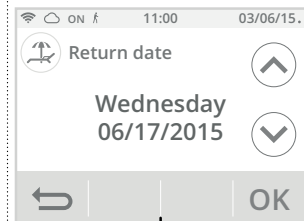

•  **Holiday mode**  
You can program an absence period during which your installation will be protected from frost. At the end of this period, the device will return to Auto mode. This guarantees you maximum savings during your holidays and an optimal level of comfort when you return.



Set the date of your return using  or  then confirm with **OK**.

The device automatically displays the countdown of days remaining before your return and your return date.

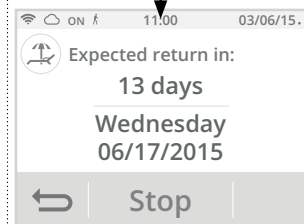



**Tip:** It is advisable to set a return date on a day prior to the actual date. In this way, you will find the right temperature when you return. Example: if you return from vacation on February 20, schedule a return to February 19 and have the right temperature on your return!

**Manual stop:** At anytime, you can stop the Holiday mode by pressing **Stop**. The device returns to the previous mode (active mode before switching on the Holiday Mode).

## MANUAL AND TEMPORARY EXEMPTION OVERRIDE TO A CURRENT OPERATING MODE

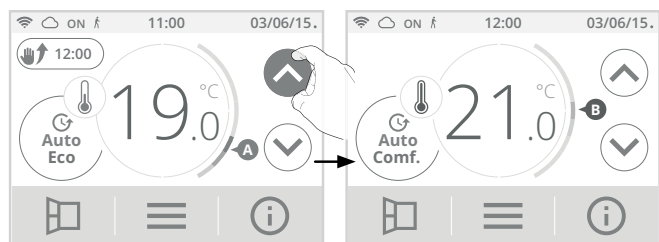
This feature allows you to modify temporarily the Eco temperature until the next programmed temperature change (via integrated programming or pilot wire) or by switching to 00:00 clock.



You can cancel this exemption at any time by pressing . The device automatically returns to the original operating mode (active mode before manual exemption).

## GAUGE CONSUMPTION, ENERGY SAVINGS

**The Energy Saving Trust (EST) and carbon trust recommends reducing temperature control down by 1°C to save up to 10% of your energy bill.**

A cursor indicates the level of energy consumption by automatically changing color: red, orange or green.

So, depending on the setting temperature, you can choose your level of energy usage. As the temperature setting increases, the consumption will be higher.

In which case?

In Auto, Comfort, Eco and Frost protection modes and whatever the temperature level.

<p><b>C - Red colour</b> High Temperature level : it is advisable to significantly reduce the setting temperature.</p>	<p><b>Setting temperature &gt; 22°C</b> When the setting temperature is higher than 22°C</p>	
<p><b>B - Orange colour</b> Average temperature level : it is advisable to slightly reduce the setting temperature.</p>	<p><b>19°C &lt; Setting temperature ≤ 22°C</b> When the setting temperature is higher than 19°C and lower or equal to 22°C</p>	
<p><b>A - Green colour</b> Ideal temperature.</p>	<p><b>Setting temperature ≤ 19°C</b> When the setting temperature is lower or equal to 19°C</p>	

## ADJUSTMENT OF SETTING TEMPERATURES

1- From the main screen, press and select Temperatures.

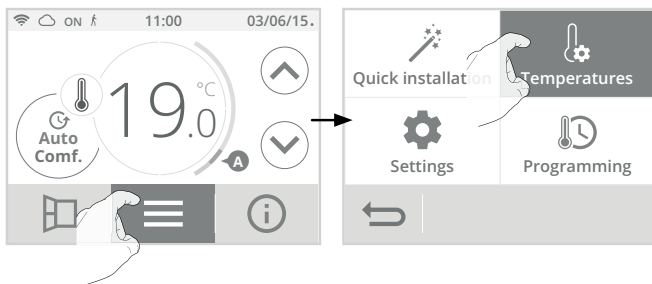

2- Select the setting temperature to be modified: Comfort, Eco or frost protection.

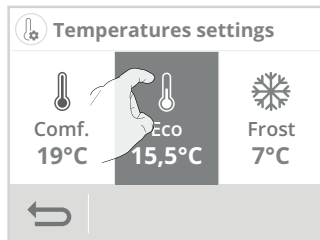

3- Adjust the desired setting temperature with or then press **OK** to confirm and return to the main screen.

### Comfort temperature

<p>Preset at 19°C</p>	<p>Adjustable from 7°C to 30°C by intervals of 0.5°C. It is possible to limit this comfort period, see page 21 for details.</p>	
-----------------------	---	--

### Eco temperature

<p>Preset at 15.5°C (equivalent to Comfort -3.5°C)</p>	<p>Adjustable from 5°C to 19°C by intervals of 0.5°C and according to the Comfort setting temperature (from Comfort -8°C to Comfort -1°C). For example, if the Comfort temperature is set to 20°C, the eco temperature is adjustable from 12°C to 19°C. <b>Important: The Eco setting temperature will never exceed 19°C.</b></p>	
--	---	--

### Frost protection temperature

<p>Preset at 7°C</p>	<p>Adjustable from 5°C to 12°C by intervals of 0.5°C.</p>	
----------------------	---	--

## CONSUMPTION INDICATION ACCUMULATED IN KWH, ENERGY SAVINGS

It is possible to see the estimation of power consumption in kWh since the last reset of the energy meter.

### • Visualization

1- Press and select Energy consumption.

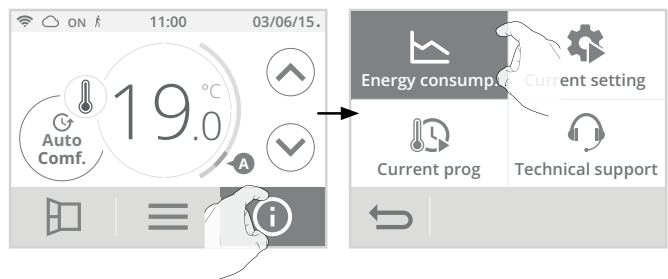

2- View the device's energy consumption in kWh over the year, current month and accumulated since the first power up or the counter reset.

Energy consumption		
2015	2000	kWh
April	300	kWh
Since 09/25/2015	36	kWh
		Reset

3- Press to exit and return to the main screen.

### • Resetting the energy meter

1- To reset the counter, press **Reset** .

2- Confirm by pressing Yes or No. The device automatically returns to the previous screen.

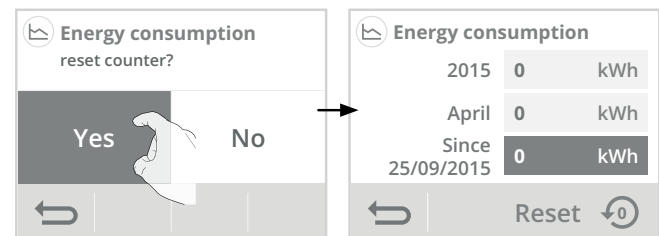

3- Press to exit and return to the main screen.

## CHILD ANTI-TAMPER, KEYPAD LOCK/UNLOCK

### • Controls lock

To lock the controls, press and hold down  for **5 seconds**.

The padlock symbol  appears on the display, touchscreen is locked.

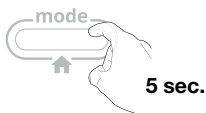
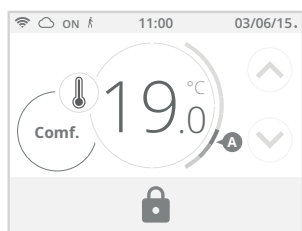

### • How to unlock controls

To unlock controls, press and hold down the button  for **5 seconds**.

The padlock symbol  disappears from the display, touchscreen is unlocked.

 **Important: when the touchscreen is locked, only the key is active.**

If the device is on heating standby mode when the touchscreen is locked, you have to unlock it for the next heating on to access the setup.

## 7 DAY AND DAILY PROGRAM INTEGRATED, ENERGY SAVINGS

### • Access to the programming mode

1- From the main screen, press  and select Programming.

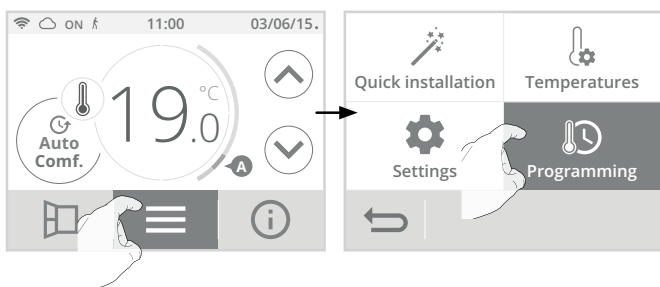

### • Choosing a pre-recorded program

2- Press Prog. assistant and then OK.

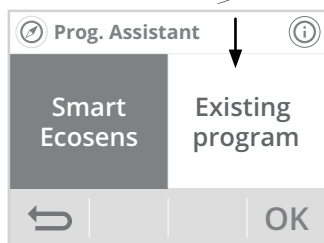
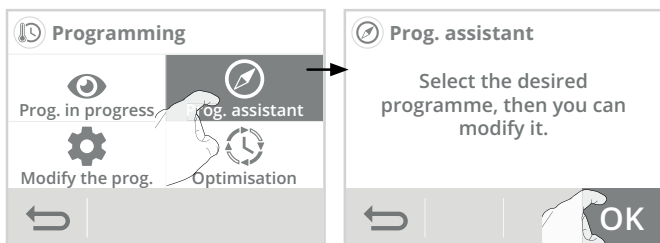

## AUTOMATIC PROGRAMMING WITH SELF-LEARNING PROCESS

### • Overview

**Auto-programming (Auto-prog):** After an initial learning period of one week, the radiator will analyze occupancy cycles to determine and implement a weekly program adapted to your lifecycle alternating periods in comfort and periods in eco, the goal being to deliver the most efficient yet comfortable and user focused heating cycle.

The product algorithm will perpetually learn and adapt to changes in your occupancy patterns, adapting week after week to optimize the heating program to any changes in your evolving occupancy patterns.

### • Operating

Upon the first activation of your radiator, the mode "auto-program" is activated by default, in mode Auto. To deactivate and change the program, see program modification and allocation page 13.

The first week of operation is a learning week during which the radiator memorizes your habits and elaborates a program for the week. It therefore defines a program built up of periods of Comfort and Eco, independently for each day of the week.

During this learning week, the radiator will provisionally function in permanent "Comfort" mode.

**Important: To ensure the auto-programming is optimized, please ensure the presence detection sensor is not interrupted by an external source,** see important information concerning the presence detection system on page 16.

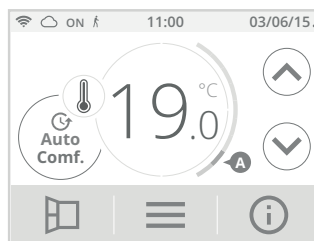

Example of display in Comfort period

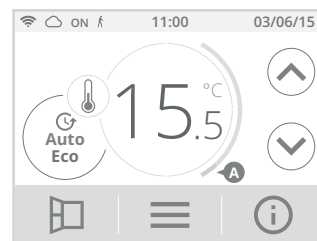

Example of display in Eco period

### • Application of the intelligent program

One week after switching on, the device will apply the new program for the next 7 days.

Then week after week the device will continue to optimize the intelligent program "Auto", adjusting the Comfort and Eco periods to fit closely with your lifestyle.

**When the product is in Frost protection mode or in heating standby mode, learning and optimisation of the intelligent program stops:** the device stores the previously recorded program from the last week before switching to the Defrost or heating standby mode.

- **Example 1:** If the product is installed in mid-season or if its installation is anticipated on the construction site, it can be switched on in stand-by mode. When you select the Auto mode, the learning week will start automatically. The device will be in permanent comfort and will memorize your habits to apply the adapted program the following week.

- **Example 2:** You select frost protection mode before going on holiday. Upon your return, when you return to Auto mode, the unit will automatically apply the previously stored intelligent program from the last week before you left.

**In the case of control by pilot wire** coming from an energy manager for example, the pilot wire will take precedence over the AUTO program which results from the Self-learning algorithm.

## 7 DAY AND DAILY PROGRAM

In this mode, you have the option of programming your radiator, by setting one of the seven programs on offer for each day of the week.

### • Choices program

The radiator is delivered by default with the self-learning mode enabled as described opposite. If this program suits your requirements, you have nothing more to do, the radiator, after the initial 7 day learning period will follow the autoprogram which will continue to tailor itself to your occupancy cycles.

If this program does not suit you, scroll through the pre-recorded programs using the navigation arrows and select the one adapted to your lifestyle by pressing directly on the screen:

• Legend

■ Comfort mode      □ Eco mode

**Program 1**

The device will operate in Comfort mode from 06:00 to 22:00 and in Eco mode from 22:00 to 06:00.

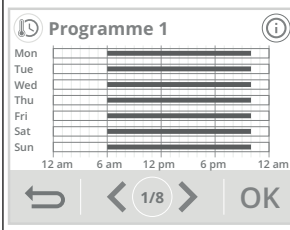

**Program 2**

The device will operate in Comfort mode from 06:00 to 09:00 and from 16:00 to 22:00 and in Eco mode from 09:00 to 16:00 and from 22:00 to 06:00.

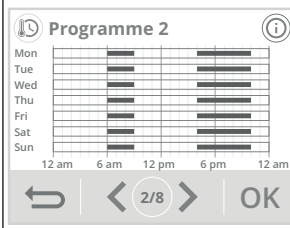

**Program 3**

The device will operate in Comfort mode from 6am to 8am, from 12pm to 2pm and from 6pm to 11pm. It works in Eco mode from 11pm to 6am, from 8am to 12pm and from 2pm to 6pm.

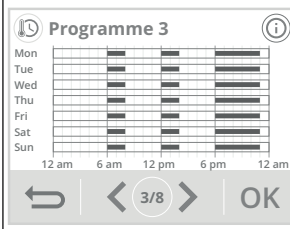

**Program 4**

Monday, Tuesday, Thursday and Friday:  
The device operates in Comfort mode from 6am to 8am, from 12pm to 2pm and from 6pm to 11pm. It works in Eco mode from 11pm to 6am, from 8am to 12pm and from 2pm to 6pm.  
Wednesday:  
The device operates in Comfort mode from 6am to 2pm and from 6pm to 11pm. It works in Eco mode from 2pm to 6pm and from 11pm to 6am.  
Saturday and Sunday:  
The device operates in permanent comfort for the 24 hours of each day.

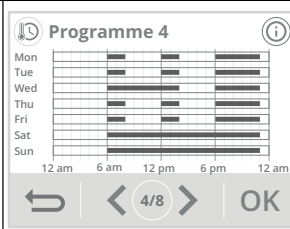

**Program 5**

Monday, Tuesday, Thursday and Friday:  
The device operates in Comfort mode from 6am to 8am, from 12pm to 2pm and from 6pm to 11pm. It works in Eco mode from 11pm to 6am, from 8am to 12pm and from 2pm to 6pm.  
Wednesday:  
The device operates in comfort mode from 6am to 8am and from 12am to 11pm. It works in Eco mode from 8am to 12pm and from 11pm to 6am.  
Saturday and Sunday:  
The device operates in permanent comfort for the 24 hours of each day.

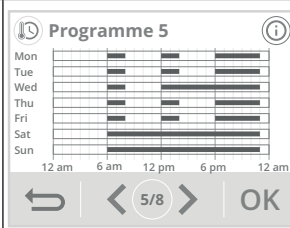

**Comfort mode**

The device will operate in Comfort mode, 24 hours a day, as regards each day selected.

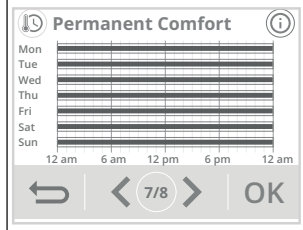

**Eco mode**

The device will operate 24 hours a day in Eco mode.

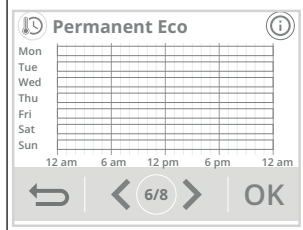

**Note :** you can set the setting temperature (see to set the setting temperatures page 12).

• **Changes in program allocation**

If you are not satisfied with the timetable of the chosen program, you can modify it day-by-day or in a group of days.

1- Press **Modify the prog.**

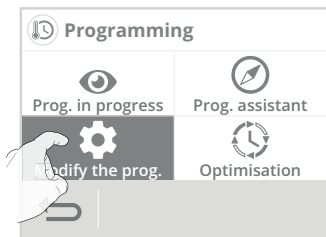

2- **Change the programming by following the steps below:**

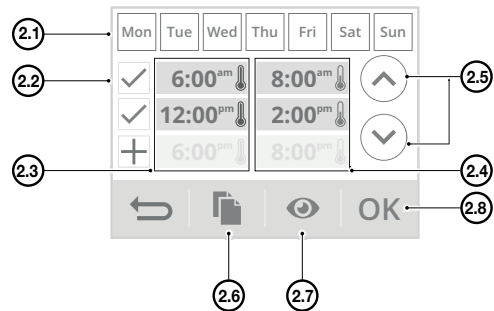

- 2.1- Select the day(s) of the week.
- 2.2- Add a comfort period.
- 2.3- Comfort periods starting times.
- 2.4- Eco periods starting times.
- 2.5- Change the scheduled periods.
- 2.6- Copy the schedules to one or more days of the week.
- 2.7- View the modified programming.
- 2.8- Confirm, the modified program appears.

<b>Mon</b>	Monday	<b>Tue</b>	Tuesday
<b>Wed</b>	Wednesday	<b>Thu</b>	Thursday
<b>Fri</b>	Friday	<b>Sat</b>	Saturday
<b>Sun</b>	Sunday		

3- Press  to exit and return to the main screen.

## • Visualization of the current program

At any time, you can view the current programming by pressing **Prog.** In progress.

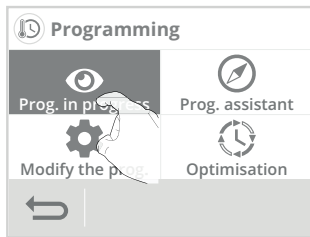

Press **mode** to exit and return to the main screen.

## DUAL OPTIMISATION FEATURE

### • Overview

**Dual function optimisation, priority to comfort or energy savings, the choice is yours:** Depending on various parameters: room inertia, ambient temperature, desired temperature, the radiator calculates and optimizes the programming for each heating period whether set to Comfort or Savings (Eco):

- In **OPTI ECO mode (efficiency priority)**, the radiator inbuilt algorithms will calculate the best compromise in order to guarantee maximum energy savings throughout the programmed increase and decrease phases.

In this mode, a slight drop in the temperature level at the beginning and end of the comfort period is allowed to maximize energy savings.

- In **OPTI COMFORT mode (priority to comfort)**, the radiator intelligence calculates the best compromise in order to guarantee maximum comfort during the programmed increase and decrease phases. In OPTI COMFORT mode, the priority is given to anticipating and maintaining the comfort temperature during periods of detected occupancy.

### • Optimisation choice

The **OPTI COMFORT** mode is activated by default.

1- Press **Optimisation**.

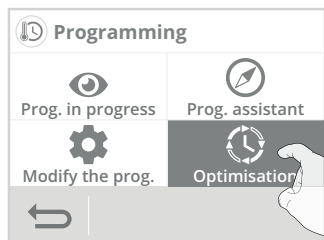

2- Select the Optimisation type you want and confirm by pressing **OK**.

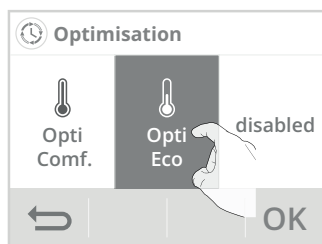

## OPEN WINDOW DETECTION, ENERGY SAVINGS

### • Important information about the open window detection:

**Important:** the open window detection is sensitive to temperature variations. The device will react to the window openings in accordance with different parameters: temperature setting, rise and fall of temperature in the room, the outside temperature, the location of the device...

If the device is located close to a front door, the detection may be disturbed by the air caused by opening door.

If this is a problem, we recommend that you disable the automatic mode opened window detection (see page 21).

You can, however, use the manual activation (see above).

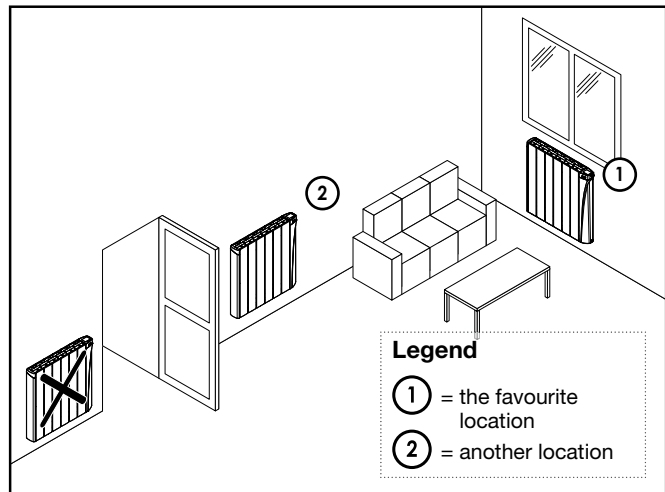

### • Overview

Lowering temperature cycle to Frost protection during aeration of a room by opened window. You can access the opened window detection from the Comfort and Auto Modes. Two ways to enable the detector:

- **Automatic activation**, the lowering temperature cycle starts as soon as the device detects a temperature change.

- **Manual activation**, the cycle of lowering temperature starts by pressing a button.

### • Automatic activation (factory settings):

To disable this mode, see page 21.

The device detects a temperature fall. An opened window, a door to the outside, can cause this temperature fall.

**Note:** The difference between the air from the inside and the outside must cause a significant temperature fall to be perceptible by the device.

This temperature drop detection triggers the change to Frost Protection mode.

### • Manual activation (activated by default):

From the main screen, press **Open Window**. The device will switch on Frost protection mode.

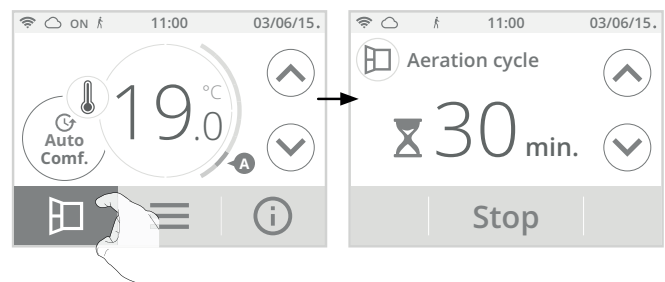

### - Aeration cycle time

The frost protection mode is active for an adjustable time of 30 min. The countdown of the aeration cycle begins and the time elapses, minute by minute. You can temporarily change the duration of the aeration cycle from 5 to 90 minutes in 5-minute intervals by pressing **Up** or **Down**. This modification will only be valid for this active, and therefore non-recurring, aeration cycle (see page 21 for permanent modification of the aeration cycle time).

**- Stopping the aeration cycle**

- **Manual shutdown:** At any time, you can stop the aeration cycle by pressing **Stop**.
- **Automatic shutdown:** At the end of the countdown, the ventilation cycle stops.

When the aeration cycle is stopped, the device automatically returns to the original operating mode (active mode before the aeration cycle is activated).

**Note:** If a sufficient rise in temperature is perceived, the device can return to the original mode (active mode before the opened window detection).

## OCCUPANCY DETECTION, ENERGY SAVINGS

**• Important information about the occupancy detection**

The occupancy detector is sensitive to temperature variations and light. It is likely to be disturbed by the following items:

- Hot or cold sources such as forced air vents, lights, air conditioners
- Reflective surfaces such as mirrors
- Animal crossing in the detection zone
- Objects moving with the wind like curtains and plants.

Disable the occupancy detection if your radiator was installed near of these.

To disable the occupancy detection, see page 20.

**Note:** the detection range varies depending on the ambient temperature.

**• Overview**

**I-sense fits your lifestyle while keeping your power consumption under control.**

With its front infrared sensor, I-sense optimizes the management of heating: it detects movement in the room where it is installed and in case of absence, automatically performs a progressive lowering of the setting temperature resulting in: energy savings. To ensure proper operation, do not block the sensor's field of view by any obstacle (curtains, furnitures ...).

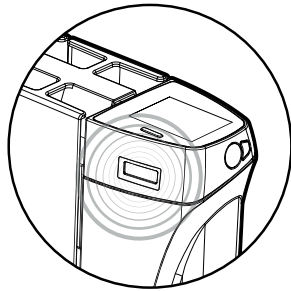

Unoccupied periods *	Lowering setting temperature
20 minutes	Comfort -1°C
40 minutes	Comfort -1,5°C
1 hour	Comfort -2°C
72 hours	Frost protection

\* Unchangeable factory settings

**Note:** when presence is detected in the room, the device automatically returns to the initial mode.

**Remarks:** by default, when the sensor is enabled and detects movement in the room, the screen lights up for a few seconds and then turns off. To delete the backlight when occupancy is detected, see page 20, advanced settings - occupancy detection: activation/deactivation.

**• Operating**

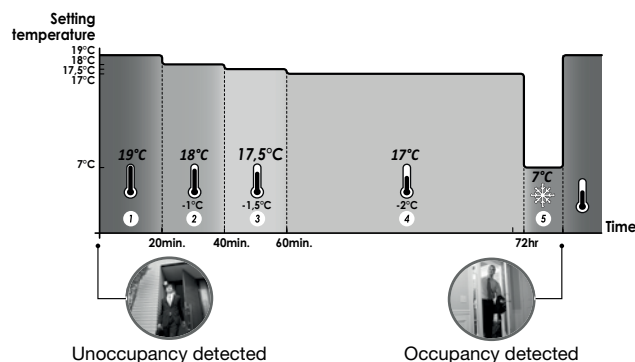

**• Divisions of the detection zone**

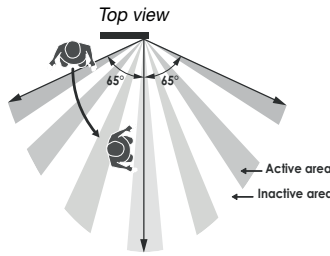

**Detection zone, for a temperature of 19°C.**

The detection zone is divided into active and inactive areas. A person that crosses the area will be detected by the infrared sensor.

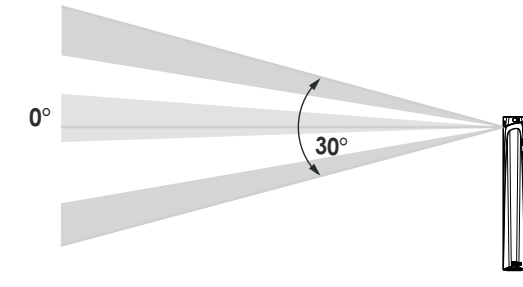

## INFORMATION ABOUT REMOTE CONTROL BY PILOT WIRE

**• Overview**

Your heating device can be controlled by a central control unit through a pilot wire, in which case the different operating modes will be remotely enabled by the programmer.

You can only control the device by pilot wire in the Auto mode. In the other modes, the orders transmitted by the pilot wire will not be executed.

In general, a pilot wire control system makes it possible to impose externally a lowering of the temperature setpoint, combined with the internal programming and the occupancy detection.

If several lowering requests appear simultaneously, priority is given to the lowest temperature setpoint, thus maximizing savings (see information on priorities for different modes on page 17).

When a signal is sent from the pilot wire, the self-learning optimisation function is suspended.

Below the different views of the display for each order sent by pilot wire:

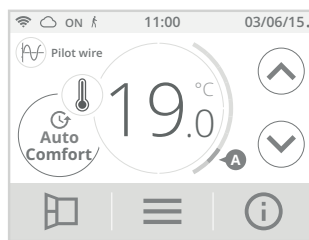

Pilot wire = **Comfort**

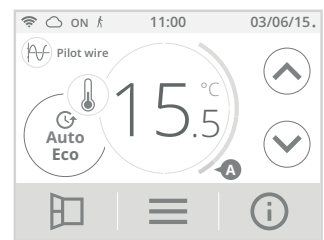

Pilot wire = **Eco**

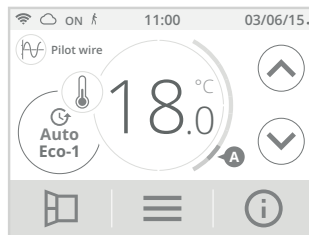

Pilot wire = **Eco - 1**  
Comfort - 1°C

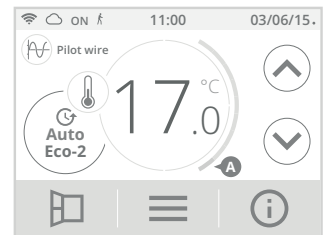

Pilot wire = **Eco - 2**  
Comfort - 2°C



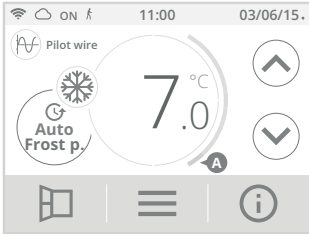

Pilot wire = Frost protection



Pilot wire = Stop (Heating standby mode)

## INFORMATION ABOUT PRIORITIES BETWEEN THE DIFFERENT MODES

### ● Principle

In **Comfort, Eco and Frost protection mode**, only orders of the occupancy sensor and those of the opened window sensor will be considered.

In **Auto mode**, the radiator can receive different orders coming from:  
 - 7 day and daily program integrated (Comfort or Eco orders) ;  
 - Pilot wire 6 orders, if connected to a central control unit ;  
 - Opened window detector ;  
 - Occupancy detector.

In general, it is the lowest received order which prevails.

If an open window detection or an occupancy absence of more than 72 hours is detected, switching to frost protection takes precedence unless a load shedding order is present on the pilot wire.

**Special case of self-programming where the temperature level in the room is decided according to the learning of the lifestyle and the optimisation mode selected (Opti Comfort or Opti Eco):**

- During the programmed passage in period Eco, if a presence is detected in the room, it will be taken into account and the appliance automatically switches to Comfort mode.  
 - During the programmed passage to the Comfort mode period, the absence detection system is temporarily suspended (30 minutes).

### ● Examples

7 day and daily programming = Comfort

+ Pilot wire 6 orders = Eco

= Eco

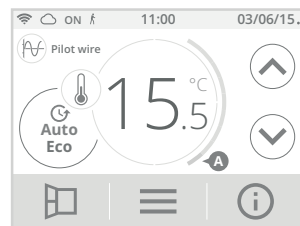

7 day and daily programming = Comfort

+ Pilot wire 6 orders = Eco

+ Occupancy detector = Frost protection

= Frost protection

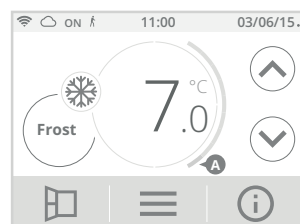

7 day and daily programming = Eco

+ Pilot wire 6 orders = Stop (heating standby mode)

+ Occupancy detector = Eco

+ Open window detector = Frost protection

= Heating standby mode



## PRODUCT INFORMATION

At any time you can view the operating status of the product.

1- From the main screen, press

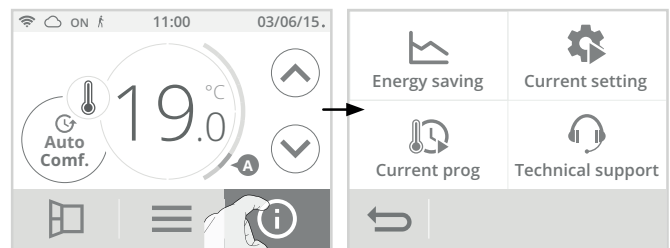

2- Press on the information you want to view. Press to exit and return to the main screen.

### Energy consumption

Energy consumption of the device in kWh over the year, current month and accumulated since the first power-up or the counter reset (see page 12 for resetting the meter).

Energy consumption		
2015	2000	kWh
April	300	kWh
Since 09/25/2015	36	kWh

Reset

### Active settings

List of all settings set on the product.  
 Press or to scroll and **OK** to exit and return to the previous screen (see page 18, 20 and 21 to modify it).

**Active settings**

- Profile: Individual housing
- Wifi connection: No
- Date format: 02\_04\_2015
- Time format: 10:37AM
- Programming in progress: Comfort
- Comfort temperature: 19°C
- Eco temperature: 15,5°C

**OK**

### Programming in progress

Program in progress during the week.

- Comfort mode
- Eco mode

(See page 13 to modify)

**Programming in progress**

Day	12 am	6 am	12 pm	6 pm	12 am
Mon	[Solid bar]				
Tue	[Solid bar]				
Wed	[Solid bar]				
Thu	[Solid bar]				
Fri	[Solid bar]				
Sat	[Solid bar]				
Sun	[Solid bar]				

### Technical support - See "Troubleshooting" page 23

**Technical support**

In case of technical assistance, communicate the information displayed on the screen to our team to identify your product and provide assistance in installation or use.

Power: 1250W  
 Software: V0.0  
 RF Chip version  
 S/N: 2536NS5012345  
 RF Chip:

# USER SETTINGS

## • Access

From the main screen, press and select Settings.

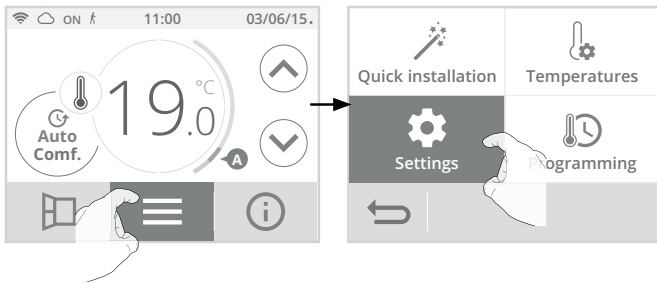

## • Settings menu

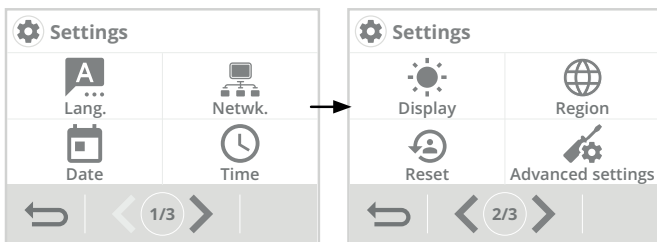

## CHOICE OF LANGUAGE USE

- 1- Press Language.
- 2- Press the desired language and confirm by pressing **OK**. The device automatically returns to the settings menu.

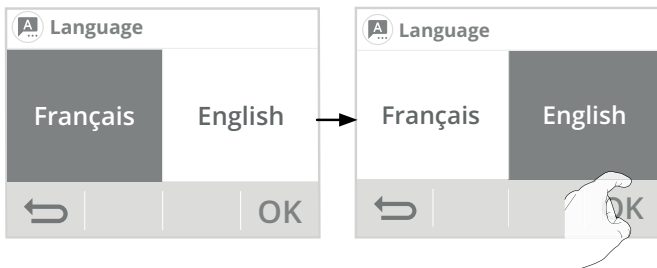

## WIFI CONNECTION

Your radiator has been specially designed to be connected directly to your home home router without the need of a hub. To pair the device with your wireless network, proceed in the following order:

- 1- Press Network.

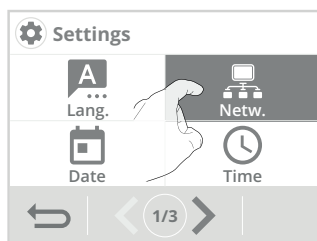

- 2- Press Wifi Connection to start the pairing process.

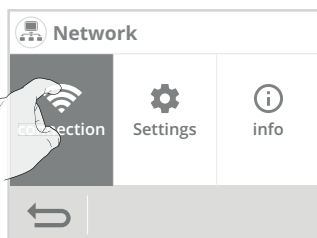

- 3- Press **OK**.

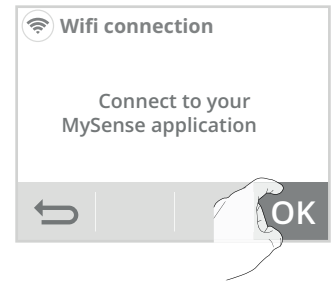

- 4- Your device is in connection mode. Please refer to the instructions on your application and follow the instructions until the complete connection of the device.

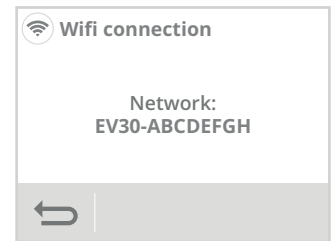

**Note:** The following 3 screens will appear when the connection is made. You have nothing to do on the product.

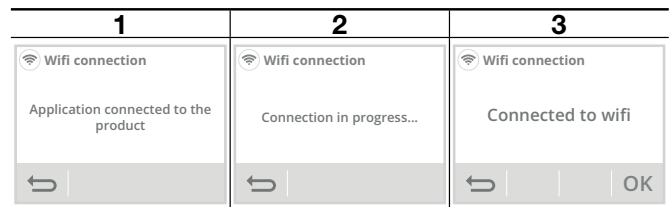

Once the product is connected, press **OK** to exit the connection mode. The unit automatically returns to the setup menu.

## • Product disconnection

If you want to disable your product from the wifi network without unpairing it, proceed as follows:

- 1- On Network display, press Settings.

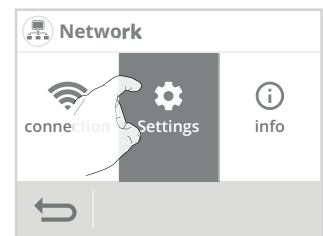

- 2- Select Wifi disabled and press **OK** to confirm.

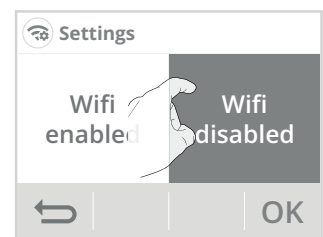

- 3- On Network display, you cannot access to Connection.

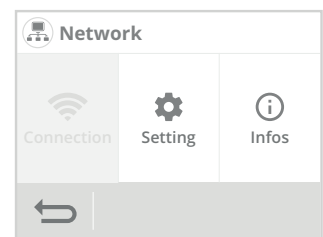

- 4- To reconnect the product to the wifi network, in the previous step simply select Wifi enabled.

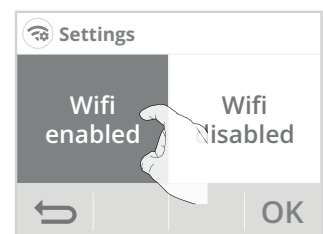

## DATE SETTING

- 1- Press Date.
- 2- Select the item to modify (day / month / year).

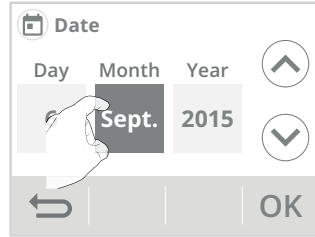

- 3- Press  $\uparrow$  or  $\downarrow$  to set and press **OK** to confirm. The device automatically returns to the settings menu.

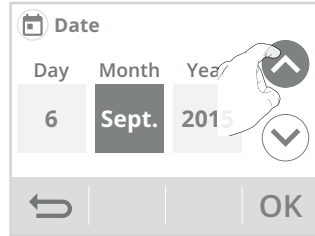

## TIME SETTING

- 1- Press Time.
- 2- Select the item to modify (hour / minute).

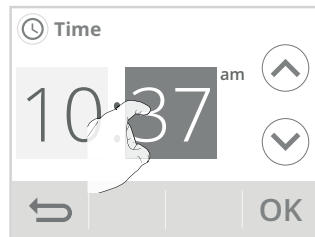

- 3- Press  $\uparrow$  or  $\downarrow$  to set and press **OK** to confirm. The device automatically returns to the settings menu.

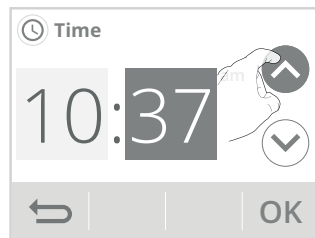

## DISPLAY

- 1- Press Display.
- 2- Select the setting to change.

### • Display menu

**Backlight time** = Display lighting time

**Backlight brightness** = Screen intensity

**Appearance** = Screen color theme

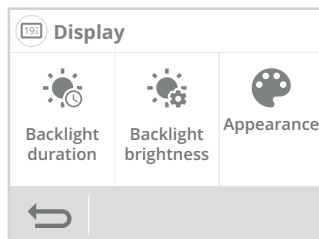

### • Backlight duration

- 1- Press Backlight duration.
- 2- The backlight time is preset to 30 seconds. To change it, use  $\uparrow$  or  $\downarrow$ .

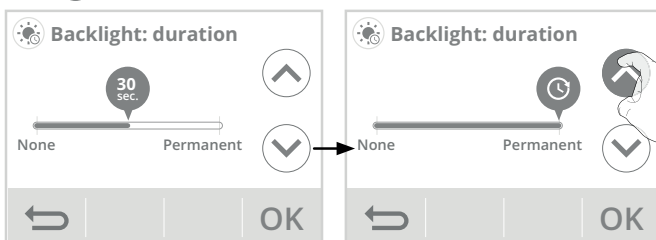

- 3- Press **OK** to confirm, the device automatically returns to the display menu.

### • Backlight brightness

- 1- Press Backlight brightness.

- 2- Select the parameter to be modified:

**Active screen** = brightness of the screen when one of the buttons is pressed

**Standby screen** = display brightness after 30 seconds can be set (see Backlight duration above) without any action on one of the buttons.

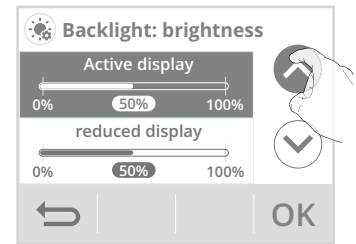

- 3- The brightness of the backlight is pre-set to 50%. To change it, press  $\uparrow$  or  $\downarrow$ .

- 4- Press **OK** to confirm, the device automatically returns to the display menu.

### • Appearance

- 1- Press Appearance.

- 2- The pre-set screen color theme is white / green. To change it, press the theme of your choice.

**White / green** = white background, green inscriptions

**Black / green** = black background, green markings

**White / orange** = white background, orange inscriptions

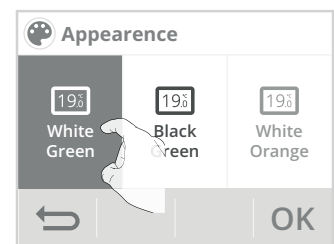

- 3- Press **OK** to confirm, the device automatically returns to the display menu.

## REGIONAL UNITS

In this setting level, you can change the temperature unit, the date and time format as well as the automatic changeover summer / winter of the timer.

- 1- Press Region.
- 2- Select the parameter to be modified.

### • Region menu

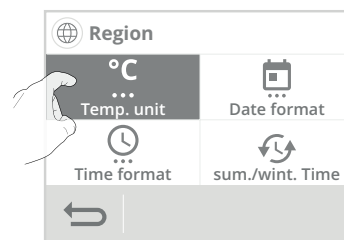

- 3- To modify, press the desired value.

Temperature unit	Date format

# ADVANCED SETTINGS

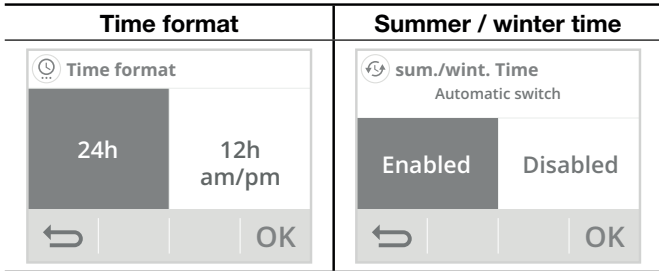

4- Press **OK** to confirm, the device automatically returns to the display menu.

## RESET USER SETTINGS

1- Press **Reset**. The list of applicable factory settings appears on the screen.

2- Press the button **Reset**.

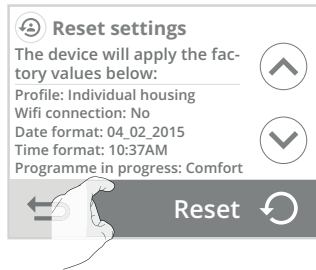

3- Press the button **Yes** to confirm the reset, and return to the Settings menu automatically.

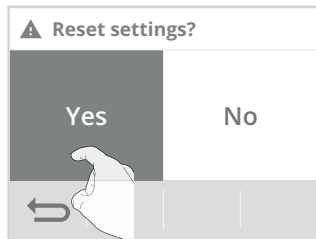

### • Access

1- From the main screen, press and then Settings.

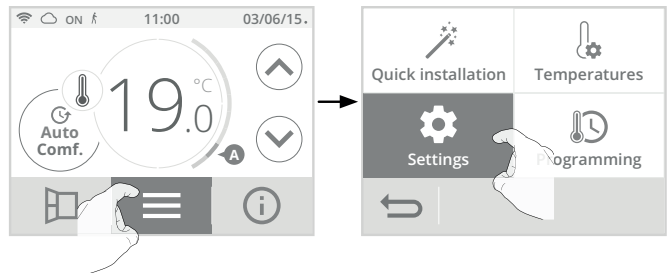

2- Scroll screens with and press **Advanced settings**.

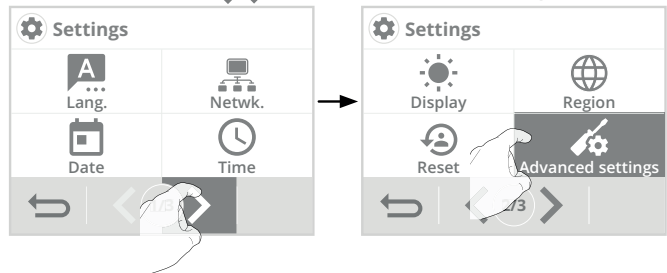

### • Advanced settings menu

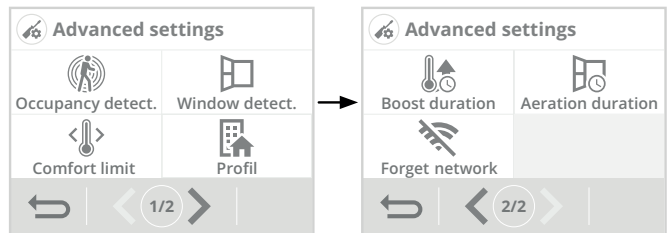

## OCCUPANCY DETECTION: ACTIVATION/DEACTIVATION

1- Press **Occupancy detection**.

2- Press the desired value and **OK** to confirm.

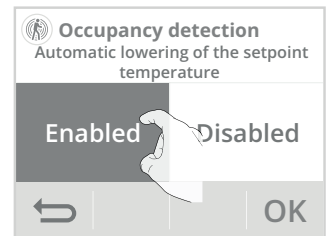

3- If you have enabled occupancy detection, press **Yes** or **No** whether or not you want the screen to light to indicate that a presence is detected in the room.

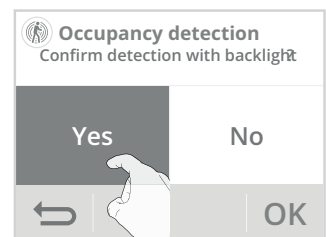

4- Press **OK** to confirm and automatically return to the advanced settings menu.

## OPEN WINDOW DETECTION: ACTIVATION/DEACTIVATION OF THE AUTOMATIC MODE

1- Press Open window detection.

2- Press the desired value and **OK** to confirm and return to the advanced settings menu.

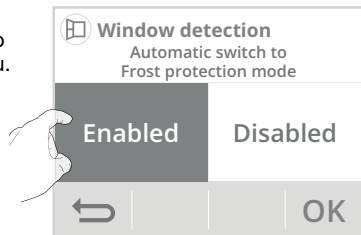

**Note:** Even if the automatic mode is disabled, you always have the option to use the manual mode (see page 15 chapter Manual Activation).

## USER PROFILE

The device has pre-set settings for each type of use.

1- Press Profile.

2- Select the profile you want and press **OK** to confirm and return to the advanced settings menu.

**Housing** = if you own your accommodation (single-family house, apartment ...)

**Public building** = if you are a landlord or a promoter (social or private rental housing)

**Hotel** = if you own / manage a hotel

**Offices** = if you own business premises

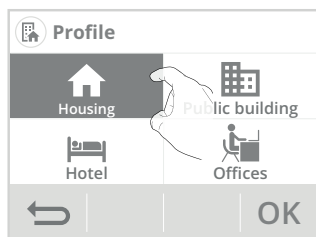

## COMFORT SETTING TEMPERATURE LIMITATION

You can limit the setting range of the setting temperature by putting a maximum and / or minimum stop to prevent unintentional temperature changes beyond those.

1- Press Comfort limitation

2- Select the item to be changed (high or low temperature limitation).

3- Press  $\uparrow$  or  $\downarrow$  to set the desired value and press **OK** to confirm. The device automatically returns to the advanced settings menu.

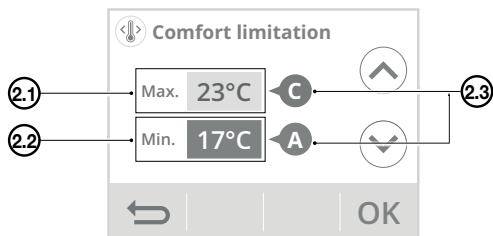

### 2.1- High-temperature limitation

Installation of a maximum stop preventing the setting temperature from rising above it.

The maximum stop is preset at 30°C. You can vary it from 19°C to 30°C in 1°C intervals.

### 2.2- Low temperature limitation

Installation of a minimum stop preventing the setting temperature from falling below it.

The minimum stop is preset at 7°C. You can vary it from 7°C to 18°C in 1°C intervals.

**2.3- Energy consumption gauge (see page 12).**

## BOOST DURATION

Boost duration is preset to 60 minutes. It is adjustable between 30 and 180 minutes in 10 minutes intervals.

1- Press Boost duration.

2- Press  $\uparrow$  or  $\downarrow$  to set the desired value and press **OK** to confirm. The device automatically returns to the advanced settings menu.

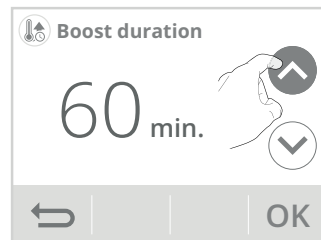

## AERATION CYCLE TIME

You can change the duration of the aeration cycle applied when the window opening is manually activated (see page 15).

The duration of the aeration cycle is preset to 30 minutes. You can change it from 5 to 90 minutes in 5-minute intervals.

1- Press Aeration time.

2- Press  $\uparrow$  or  $\downarrow$  to set the desired value and press **OK** to confirm. The device automatically returns to the advanced settings menu.

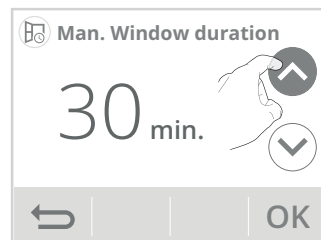

## FORGET WIFI NETWORK

To delete permanently the product Wifi network, proceed in the following order:

1- Press Forget Wifi network.

2- Press **Reset**.

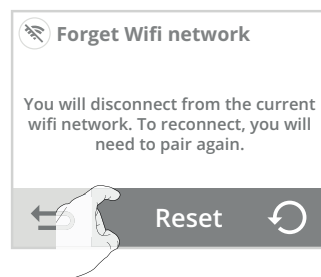

3- Press **Yes** to confirm the reset and return automatically to the advanced settings menu.

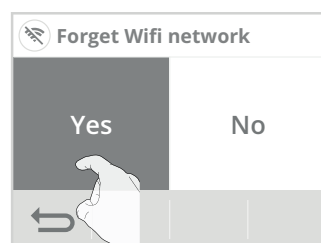

# EXPERT SETTINGS

## (RESERVED TO THE INSTALLER)

### • Access

1- From the main screen, press and then Settings.

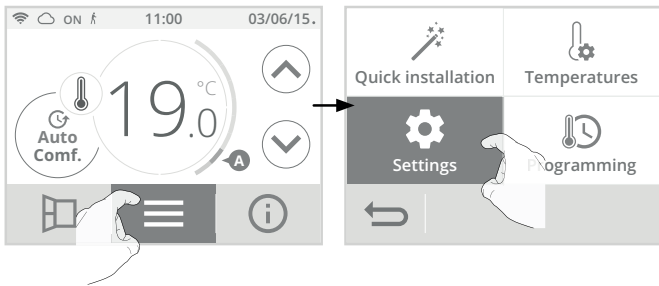

2- Scroll through the screens with and press Expert Settings.

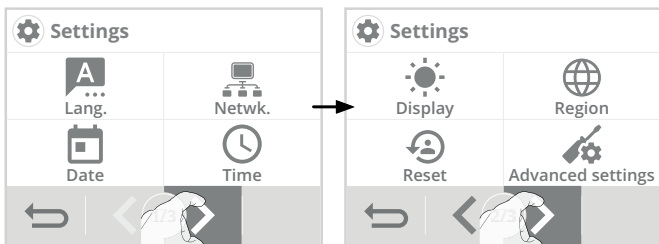

### • Expert settings menu

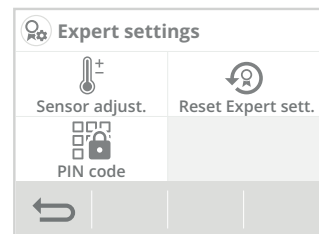
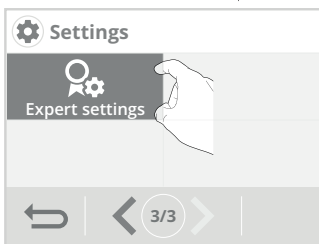

## AMBIENT TEMPERATURE SENSOR

### • Overview

**Important: This operation is reserved for professional installers only; any wrong changes would result in control anomalies.**

In which case if the temperature measured (measured by a reliable thermometer) is different by at least 1°C or 2°C compared to the setting temperature of the radiator.

The calibration adjusts the temperature measured by the ambient temperature sensor to compensate for a deviation from + 5°C to - 5°C by intervals of 0.1°C.

1- Press Sensor adjustment.

2- Press **OK** after reading the recommendations and proceed with the adjustment.

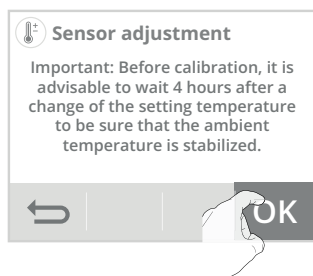

3- Enter the ambient temperature measured by your thermometer by pressing or . The device automatically proposes the temperature difference to be corrected, validate by pressing **OK**.

### A- If the room temperature difference is negative, example :

Setting temperature (what you want) = 20°C.

Ambient temperature (what you read on a reliable thermometer) = 18°C.

**Difference measured = -2°C.**

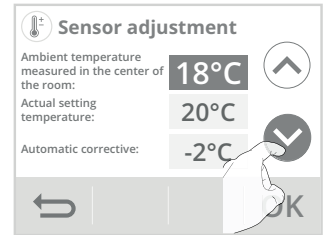

### B- If the room temperature difference is positive, example :

Setting temperature (what you want) = 19°C.

Ambient temperature (what you read on a reliable thermometer) = 21°C.

**Difference measured = +2°C.**

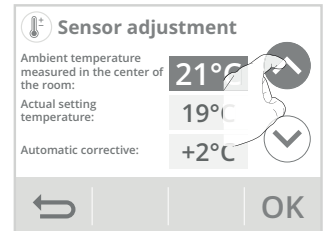

4- The appliance informs you that the temperature difference has been corrected and that it will be noticeable in a few hours. Press **OK**, the device automatically returns to the expert settings menu.

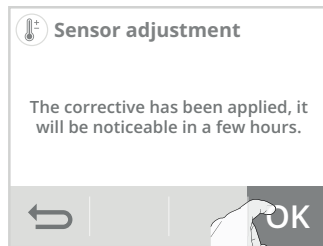

## PIN CODE LOCK

### • Overview

Your heating device is protected by a safety code against non-authorized use. The PIN code (Personal Identity Number) is a customisable 4 numbers code. When enabled, it prevents access to the following settings:

- Selecting the Comfort mode : The access to the Comfort mode is forbidden, only the Auto, Eco and Frost protection modes are available.
- Minimum and maximum limits of the set temperature range (the Comfort temperature modification is forbidden out of the authorised setting range).
- Programming mode.
- Optimisation choice.
- Occupancy detection settings.
- Open window detection settings.
- Setting the Eco mode temperature lowering-level.
- Setting the Frost protection temperature.
- Ambient temperature sensor adjustment.

### • Activation/deactivation of the PIN code

1- Press PIN code.

2- Press the desired value and **OK** to confirm. If you have activated the PIN code, the list of prohibited settings appears. Press or to scroll it and **OK** to confirm.

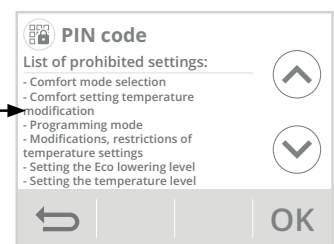
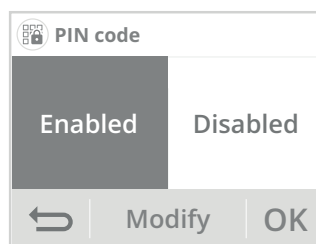

## ● Customizing the PIN code

1- Press Modify.

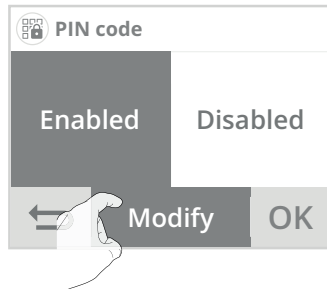

2- By default registered PIN code is 0000. Enter 0000 to initialize it and then, to modify it, enter the 4 digits of your choice by selecting them directly on the screen. Press **OK** to confirm the new PIN and return to the Expert settings menu.

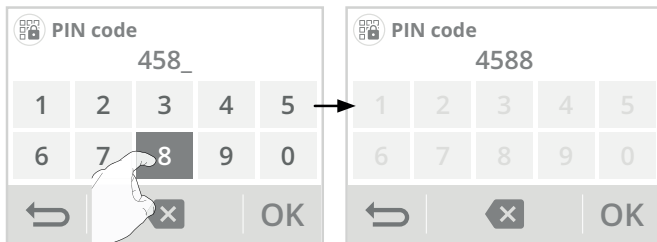

**Note:** If you are mistaken in the code, press **X** to delete.

The locked settings are then identified with a small padlock  on the access button.

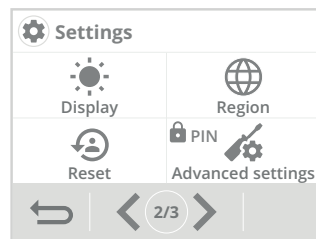

The PIN code is always requested to access to the locked settings.

## RESET EXPERT SETTINGS

1- Press Reset expert settings. The list of applicable factory settings appears on the screen.

2- Press the button Reset .

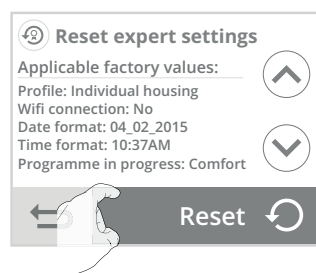

3- Press Yes to confirm the reset and return automatically to the Expert Settings menu.

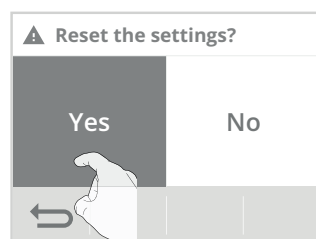

# POWER CUT

## OTHER REMOTELY MANAGEMENT BY POWER SHUTDOWN



**Important :** the power supply of the device should be cut when working on the electrical system only. The load shedding does not be operated by an additional system with mechanized power shutdown (with contactor...). Unlike pilot wire shedding, the load shedding with frequent mechanized power shutdowns can cause deterioration of the device depending of the quality of switching elements used. This type of deterioration would not be covered by the manufacturer's warranty. If remotely stop or standby orders should be frequently operated, you must use the pilot wire.

## IN CASE A POWER CUT, BACKUP

The device will start up again without any outside input being required – you do not have to do anything. All of the settings and the correct time will be saved. When the main power supply returns, your device will again operate using the correct time and the settings that were programmed before the power cut (as regards desired temperatures, operating modes, programs, etc.). It will start up again in the mode which was active before the power outage.

### - After short power cuts (less than 3 days),

The device will start up again without any outside input being required – you do not have to do anything. All the settings and the correct time will be saved.

When the main power supply returns, your device will again operate using correct time and the settings that were programmed before the power cut (as regards desired temperature, operating mode, programs, etc.). It will start up again in the mode which was active before the power outage.

### - For longer power supply cuts (more than 3 days),

checkthetimersetting.alltheothersettingsareautomaticallyandpermanently saved.

# TROUBLESHOOTING

## DIAGNOSIS SUPPORT

### ● Wifi connection

When the device is connected to your wifi network has encountered an anomaly, an error message appears on the screen.

This message indicates that the device can not connect to the wireless network.

You may have been mistaken in entering the digits of your wifi key into the device.

Check that your device and your internet box are plugged in and turned on.

- Press **Try again** to restart the wifi pairing procedure and follow the instructions on the screen.

- Press **OK** to delete the error message and return to the main screen: the device is not connected to the wifi.

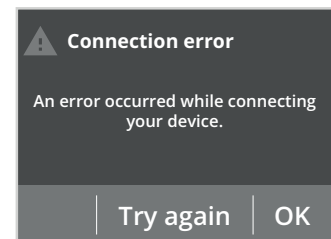

### **The device won't connect to the Wifi network.**

The I-sense only works with a 2.4Ghz network.

Following an update of your Internet box, it is possible that a 5Ghz network has been created. Please check that your network is in 2.4Ghz.

If this is not the case, please refer to the manual of your internet box to change it or call your internet provider to make the change.

### ● Updating the device software

We periodically perform software updates to optimize the performance of your device. When a software update is available for download, a notification appears on the screen and the device automatically downloads it. You have nothing to do, just wait a few minutes.

During the update, all your settings are preserved. When the update is complete, a notification appears on the screen. Press **OK**, the device automatically returns to the original operating mode (active mode before the software update).



When the software update has encountered an abnormality, an error message appears on the screen. This message indicates that the update server is having difficulty communicating with your device.

The update process may have stopped because you accidentally restarted your device or disconnected it from your Wi-Fi network.

Make sure that your device is plugged in, turned on and connected to your wireless network (the symbol should be displayed in the top panel of the screen).

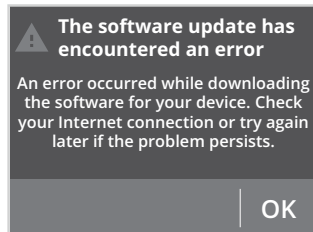

## ● Heating body

### The device doesn't heat:

- Check the position of the circuit breaker/power supply protection fuse in your fuse board.
- Check the active operating mode (see page 10), you could be in "Heating standby mode" or in Auto mode, with an imposed stop order by the energy manager (see page 16).
- Check the ambient temperature using a thermometer: if it is elevated, the device has reached the desired temperature setting, therefore it is normal that it doesn't heat more.
- Switch the power off for 5 seconds at the mains supply then switch back on again.

### The room temperature is not high enough, the device is not providing enough heat:

- Check the active operating mode (see page 10), you may be in Eco, Frost protection, Standby or in Auto mode, with an imposed stop order by the integrated programming or the energy manager.
- Activate the permanent Comfort mode.
- Check the active temperature setting and increase it if necessary (see page 12).
- Check the adjustment of the setting temperature limit (see page 21).
- If the problem persists, check the radiator sizing compared with the room dimension and insulation.

### The device heats continuously and is hot on the surface:

- Check that the device is not influenced by an airstream.
- Check that the set temperature has not been changed.
- In operation, it is normal that the device surface is hot.
- If the problem persists, check the radiator sizing compared with the room dimension and insulation.

### Several situations can generate a slight metallic slam.

- The device is fixed on an irregular wall.
- The device is fixed on an uninsulated wall.
- The device is in a stream of cold air.
- The device is badly positioned in the wall-mounting brackets.
- Heat up or sudden temperature change.

**Important : Failure of the internal thermal limit due to overheating caused by the user eg covering with clothing is not covered by warranty.**

## ● Controller

### The ambient temperature is lower than the setting temperature :

- Check the programming mode. You may be in eco period.
- Check the time setting.
- Otherwise, switch the power off for 5 seconds at the mains supply then switch back on again.

### The ambient temperature measured by a thermometer doesn't correspond to the setting temperature after several hours.

- An offset is always possible, you can refine the device setting (see page 22).

### The device does not heat while the heating indicator is on:

- The heating symbol is lit on the display, the unit is cold, contact your installer.

### The device does not automatically a lower of the temperature in the period of absence:

- Check that the occupancy detection is enabled (see page 20).
- Check that nothing disturb the operation of the occupancy detection (see page 5 and 16).

### After a subsequent temperature drop at the opening of a window, the device will not enter in Frost protection mode :

- Check that the automatic mode of the open window detection is enabled (see page 21).
- Check the location of your radiator (see page 15).
- Check that the temperature difference between the room air and outside air is significant.

### The device automatically enters in Eco or Frost protection mode in your presence and closed windows :

- If the device is connected to a central programming via pilot wire, check the programming of the central.
- Disable the automatic open window detection mode (see page 21).
- Disable the occupancy detection (see page 20).

### The device is in self-programming mode and you observe a delay between the active mode Comfort or Eco and your requirement:

- The self-programming works by detecting and learning of your occupancy cycles, the device defines the future program by adapting to the different observations made in occupancy in the previous week.

If your lifestyle is very irregular, for example every week is different, it is impossible to determine exactly your requirements in advance. Self-programming, such as weekly and daily programming, can never fully match. In this case, it is advisable to use only the presence / absence detection and to program your device in permanent Comfort (see pages 13 and 20).

- The optimisation function can generate slight offsets to guarantee the level of comfort at the right time or to save energy by slightly anticipating an Eco passage.

- Check that the presence / absence detector is not disturbed or blocked by an external source (see page 16).

### The device is self-programmed but no period is programmed (ECO registration is displayed on the display):

- Check that the presence / absence detector is not disturbed or blocked by an external source (see page 16).

### The device is in self-programming mode but the ambient temperature is not sufficient at the beginning of the period. Comfort:

- Check the Eco lowering level (see page 12):
  - If it is below  $-3.5^{\circ}\text{C}$ , For example  $-5^{\circ}\text{C}$ , the difference between the Comfort and Eco setpoint temperature is too high, which explains the perceived temperature difference at the beginning of the Comfort period. It is therefore recommended to set it to its initial value  $-3.5^{\circ}\text{C}$ .
  - If the Eco lowering level is  $-3.5^{\circ}\text{C}$ , set it to  $-2^{\circ}\text{C}$  to reduce the difference between the Comfort and Eco setpoint temperatures.

### The device is in Auto mode, remotely controlled by an energy manager or programmer but the programming orders are not executed by the device:

- Make sure the energy manager or programmer is in good condition, refer to the user instructions.
- Change the batteries of the energy manager or the programmer if this one contains it.

### No symbol appears on the display screen.

- Check the position of the circuit breaker / power supply protection fuse in your distribution / fuse board.

### You want to increase or decrease the setting temperature but pressing a key on the keyboard has no effect.

- If the padlock symbol is displayed, the keypad lock is enabled. Unlock the keypad as shown in the manual, child anti-tamper section (see page 13).
- Check the PIN code lock and the limitation of the Comfort setting temperature (see pages 21 and 22).

### You made a mistake while setting the advanced settings:

- Just restore factory settings – see the "Reset settings" paragraph (page 20 and 23). This will erase any programs that you would have implemented.

**If the problem persists, then contact your reseller.**



# TECHNICAL INFORMATION

## MAINTENANCE

Before any maintenance work, select the Heating standby mode by pressing  and wait until the device is cold.

The device can be cleaned with a damp cloth; **never use abrasives or solvents.**

## PRODUCT LABEL

The product label is the identity card of your device. It contains all informations required of its traceability through time.

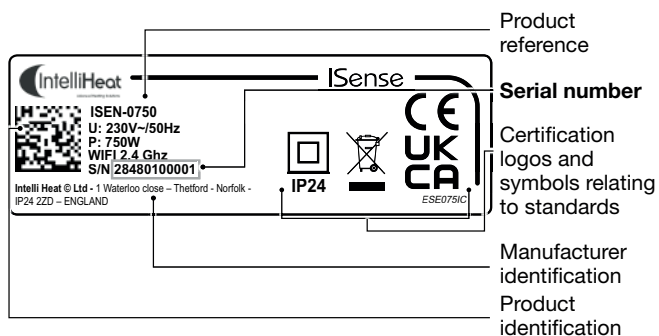
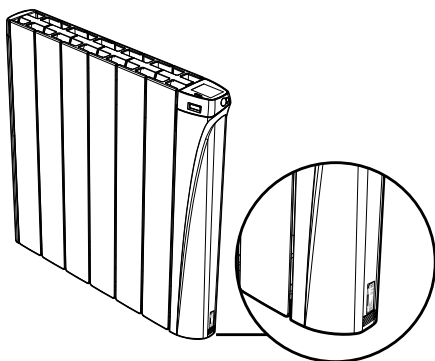

**Important:** the serial number allows the manufacturer to identify your device. If you contact your installer about the product you have purchased, take yourselves previously the references of your device. **Make sure to keep the instructions manual even after the product installation.**

## DIMENSIONAL SPECIFICATIONS

References	Power outputs (W)	Width (mm)	Height (mm)	Depth* (mm)	Number of elements
ISEN-0750	750	509	580	80	5
ISEN-1000	1000	590	580	80	6
ISEN-1250	1250	752	580	80	8
ISEN-1500	1500	832	580	80	9
ISEN-2000	2000	1075	580	80	12

\* For the depth of ISense radiators installed (including the brackets), add 40mm to the value of their depth.

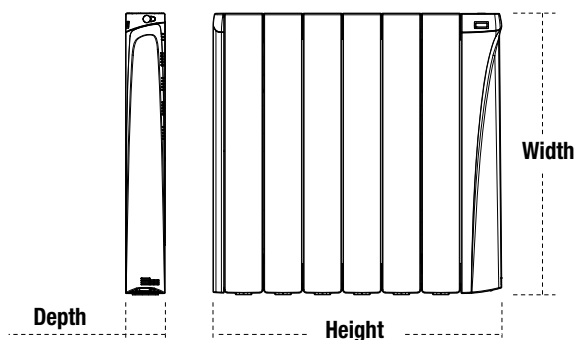

## TECHNICAL INFORMATION

### General specifications:

- Power supply: 230V +/-10 % AC 50Hz.
- Radio frequencies: WIFI 802.11 b/g/n 2,4 Ghz.
- Maximum RF power transmitted: <15dbm.
- Consumption in heating standby mode: <2W.
- Proportional Integral Derivative control, with engagement by triac.
- Thermal Safety: The radiators are equipped with a system to protect the device against overheating.

### Environment:

- Safety: Classe II, IP24.
- Storage temperature: -20°C to +70°C.

### Features:

- Setpoint adjustment range Confort +7°C to +30°C.
- Saving settings users in case of power failure.
- Auto-programmable: automatic learning of users habits to determine and implement a program adapted to your lifecycle.
- Programming: assigning a Comfort / Eco profile for each day of the week.
- 7 programming profiles.
- Pilot wire 6 orders.

### WiFi specifications

- Use of standard WiFi: IEEE802.11b / g / n 2.4GHz.
- The network name (SSID) must be between 1 and 32 characters without an accent. Spaces and special characters are allowed.
- The WiFi network password must be between 8 and 64 characters without an accent. Spaces and special characters are allowed.
- It is recommended to use the security type WPA2 AES.
- The range of Wi-Fi in a standard home is generally 10-12 metres, depending on the presence of obstacles.
- Limit interference from wireless devices.
- Check that there are no obstacles between the device and the internet router. The WiFi signal strength can be reduced by electrical devices, thick walls, etc.
- The use of a WiFi repeater/extender is recommended for larger homes/buildings.
- Ports **443** and **8883** of your internet box must be open to facilitate proper connectivity of the devices.
- The use of the following domain name is required: \*.imhotepcreation.com.

### UKCA declaration of conformity:

We, Neomitis Ltd, hereby declare under our sole responsibility that the products described in these instructions comply with statutory instruments 2017 No. 1206 (Radio Equipment Regulations), 2012 No.3032 (ROHS), 2019 No. 539 (The Ecodesign for Energy-Related Products and Energy Information (Amendment) (EU Exit) Regulations) and following designated standards listed below:



- Radio Equipment Regulations 2017 (2017 No. 1206):
  - Article 3.1a : EN 60335-1:2012/ AC:2014/ A11:2014/ A13:2017/ A1:2019 / A14:2019/ A2:2019/ A15:2021, EN 60335-2-30:2009/ A11:2012/ AC:2010/ AC:2014 /A1:2020/ A12:2020/ A13:2022/ A2:2022, EN 62233:2008/ AC:2008
  - Article 3.1b : EN 301 489-1 V1.9.2
  - Article 3.2 : EN 300 328 V2.2.2
- RoHS Regulations 2012 (2012 No.3032) : EN IEC 63000:2018

### INTELLI HEAT® Advanced Heating Solutions

1 Waterloo close – Thetford - Norfolk - IP24 2ZD – ENGLAND  
Email: support@intelligentheat.co.uk - Web site: intelligentheat.co.uk

**Compliance declaration:** We hereby declare under our sole responsibility that the products described in these instructions comply with the provisions of Directives and harmonized standards listed below:



- RED 2014/53/EU:
  - Article 3.1a (Safety): EN 60335-1:2012 +A11:2014 +A13:2017 +A1:2019 +A2:2019 +A14:2019 +A15:2021 / EN 60335-2-30:2009 +A11:2012 +A1:2020 +A12:2020 +A2:2022 +A13:2022 / EN 62233:2008/ EN 50385:2017
  - Article 3.1b (EMC): ETSI EN 301489-1 V2.2.3 (11-2019)/ ETSI EN 301489-17 V3.2.4 (09-2020)
  - Article 3.2 (RF): ETSI EN 300 328 V2.2.2 (07-2019)
- ROHS 2011/65/EU, amended by Directives 2015/863/EU and 2017/2102/EU : EN IEC 63000:2018
- ERP directive 2009/125/EC: standard 2015/1188/EU.



The symbol , affixed on the product indicates that you must dispose of it at the end of its useful life at a special recycling point, in accordance with European Directive WEEE 2012/19/EU. If you are replacing it, you can also return it to the retailer from which you buy the replacement equipment. Thus, it is not ordinary household waste. Recycling products enables us to protect the environment and to use less natural resources.

# INFORMATION REQUIREMENTS FOR ELECTRIC LOCAL SPACE HEATERS

Item	Symbol						Unit
<b>Heat output</b>							
Nominal heat output	$P_{nom}$	ISEN-0750	ISEN-1000	ISEN-1250	ISEN-1500	ISEN-2000	kW
		0.75	1.0	1.25	1.5	2.0	
Minimum heat output (indicative)	$P_{min}$	ISEN-0750	ISEN-1000	ISEN-1250	ISEN-1500	ISEN-2000	kW
		0	0	0	0	0	
Maximum continuous heat output	$P_{max,c}$	ISEN-0750	ISEN-1000	ISEN-1250	ISEN-1500	ISEN-2000	kW
		0.75	1.0	1.25	1.5	2.0	
<b>Auxiliary electricity consumption</b>							
At nominal heat output	$e_{l,max}$	None					kW
At minimum heat output	$e_{l,min}$	None					kW
In heating standby mode	$e_{l,SB}$	0					kW
<b>Item</b>							<b>Unit</b>
<b>Type of heat input, for electric storage local space heaters only</b>							
Manual heat charge control, with integrated thermostat							NO
Manual heat charge control with room and/or outdoor temperature feedback							NO
Electronic heat charge control with room and/or outdoor temperature feedback							YES
Fan assisted heat output							NO
<b>Type of heat output/room temperature control</b>							
Single stage heat output and no room temperature control							NO
Two or more manual stages, no room temperature control							NO
With mechanic thermostat room temperature control							NO
With electronic room temperature control							NO
Electronic room temperature control plus day timer							NO
Electronic room temperature control plus week timer							YES
<b>Other control options</b>							
Room temperature control, with presence detection							YES
Room temperature control, with open window detection							YES
With distance control option							YES
With adaptive start control							YES
With working time limitation							NO
With black bulb sensor							NO
<b>Contact details</b>							
INTELLI HEAT© Advanced Heating Solutions - 1 Waterloo close – Thetford - Norfolk - IP24 2ZD – ENGLAND							

# NOTES

A series of horizontal dotted lines for writing notes.

# PLEASE TAKE NOTE



## THIS RADIATOR IS DOUBLE INSULATED

Being double insulated, the cable from this radiator does not carry an Earth wire, it has a Live (brown), Neutral (grey) and a **BLACK** wire, which is a pilot wire. **Never connect the black Pilot Wire to an Earth, Live or Neutral connection**, if this occurs it will destroy the thermostat. The black pilot wire is a signal wire, only to be connected to an external programmer. Please contact INTELLI HEAT for advice on such systems. If the pilot wire is not used it must be properly insulated and isolated to avoid accidental connection.

### CLASSE II



Double insulated



**INTELLI HEAT© Advanced Heating Solutions**  
1 Waterloo close – Thetford - Norfolk - IP24 2ZD – ENGLAND  
Email: [support@intelligentheat.co.uk](mailto:support@intelligentheat.co.uk) - Web site: [intelligentheat.co.uk](http://intelligentheat.co.uk)